

# Grove GMK5095

## Product Guide



 100 t

 60 m

 10 - 22 m

 83 m

All-Terrain Crane • AT-Kran

Grue Automotrice Routière

Grúa Todo Terreno Rapida • Gru Fuoristrada Veloci

Вездеходный подъемный кран

# Contents • Inhalt • Contenu • Contenido Contenuto • Содержание

Specification	3
Technische Daten	4
Caractéristiques techniques	5
Características	6
Caratteristiche	7
Технические характеристики	8
Data • Daten • Caractéristiques • Datos • Dati • Данные	10
Dimensions • Abmessungen • Encombrement • Dimensiones • Dimensioni • Размеры	11
Counterweight • Gegengewicht • Contrepoids • Contrapesos • Contrappesi • Противовес	12
Load charts • Traglasten • Capacités de levage • Capacidades • Capacità • Таблицы грузоподъемности	
Notes • Hinweise • Notes • Notas • Note • Примечания	14
Working Range • Arbeitsbereiche • Diagramme de levage • Gama de trabajo	
Area di lavoro • Грузовысотные характеристики	15
Telescopic Boom • Teleskopausleger • Flèche principale • Pluma telescópica	
Braccio telescopico • Телескопическая стрела	16
Jib configurations • Kombination der Auslegerverlängerung • Combinaisons de l'extension treillis	
Configuración con extensiones de pluma • Combinazioni delle prolunghe del falcone • Конфигурация стрелы	21
Swingaway (hydraulic luffing) • Klappspitze (hydraulisch wippbar) • Extension treillis (déport hydraulique)	
Plumín (angulable hidráulicamente) • Falcone (brandeggio idraulico) • Удлинитель стрелы с гидравлическим изменением вылета.	
Boom extension (hydraulic luffing) • Auslegerverlängerung (hydraulisch wippbar) • Extension treillis (déport hydraulique) • Extensión de pluma (angulable hidráulicamente) • Jib (brandeggio idraulico) • Удлинитель стрелы с гидравлическим изменением вылета.	22
Working Range • Arbeitsbereiche • Diagramme de levage • Gama de trabajo	
Area di lavoro • Грузовысотные характеристики	28
Integrated heavy duty jib • Integrierte Schwerlastspitze • Flèche intégrée haute résistance	
Pluma integrada de alta resistencia • Braccio integrato ad alta resistenza	
Интегрированная стрела для тяжелых условий эксплуатации	29
Symbols • Symbolerklärung • Glossaire des symboles • Glosario de símbolos • Glossario dei simboli • Символы	35



Manitowoc Crane Care is the Manitowoc's unparalleled product support organisation. Manitowoc Crane Care combines all aspects of parts, service, technical documentation, technical support and training into one organisation. The program includes all of the Manitowoc's brands, which include, Potain, Grove, Manitowoc and National Crane.

For the care of your crane and the prosperity of your business, Manitowoc Crane Care is your single source for customer support. Wherever, whenever, whatever – we're there.

Manitowoc Crane Care vereint alle Serviceleistungen von Manitowoc im Produktsupport vor und nach dem Verkauf: Ersatzteile, Service, technische Dokumentation, technischer Support und Schulung, alles unter einem Dach. Dieser Service erstreckt sich auf alle Marken von Manitowoc: Potain, Grove, Manitowoc und National Crane.

Damit Ihr Kran leistungsfähig bleibt und Ihr Erfolg gesichert ist, bietet Ihnen Manitowoc Crane Care einen umfassenden Support aus einer Hand. Zu jeder Zeit, an jedem Ort, für jeden Fall – wir sind für Sie da.

Organisation hors pair dédiée au support technique des produits de Manitowoc, Manitowoc Crane Care réunit au sein d'une même entité tous les aspects du service : pièces de rechange, service après-vente, publication technique, assistance technique et formation. Ce programme s'adresse à toutes les marques de Manitowoc : Potain, Grove, Manitowoc et National Crane.

Pour assurer l'entretien de vos grues et la prospérité de votre entreprise, Manitowoc Crane Care constitue votre unique interlocuteur du service à la clientèle. Où que vous soyez, quel que soit votre besoin, vous pouvez toujours compter sur nous !

Manitowoc Crane Care, es la organización post-venta y soporte técnico de Manitowoc. Manitowoc Crane Care combina todos los aspectos de piezas de repuesto, servicio, documentación técnica, apoyo técnico y formación en un único lugar. El programa también incluye todas las ramas Manitowoc que engloba Potain, Grove, Manitowoc y National Crane.

Para el cuidado de su grúa y la prosperidad de su negocio, Manitowoc Crane Care, es la forma más sencilla de ayudarle. Donde sea y cuando sea, nosotros estamos allí.

Manitowoc Crane Care è l'ineguagliabile organizzazione di supporto di Manitowoc. Manitowoc Crane Care gestisce tutte le attività legate a pezzi di ricambio, documentazione tecnica, assistenza tecnica e formazione riunite in un unico punto di riferimento. Questo servizio è attivo per tutti i marchi di Manitowoc e precisamente Potain, Grove, Manitowoc e National Crane.

Per l'assistenza delle Vostre gru e per la redditività dei Vostri investimenti, Manitowoc Crane Care è l'insostituibile Vostra risorsa. In ogni posto, tutte le volte, per qualsiasi necessità – noi ci siamo

Manitowoc Crane Care - это не имеющая аналогов организация, входящая в Manitowoc и осуществляющая техническую поддержку продукции. Manitowoc Crane Care занимается всеми аспектами, связанными с запасными частями, услугами, технической документацией, технической поддержкой и обучением. Программа включает все торговые марки Manitowoc, в том числе, Potain, Grove, Manitowoc и National Crane.

Manitowoc Crane Care является единой точкой контактов для всех клиентов компании, где они могут получить полное обслуживание для используемых ими кранов, что, в свою очередь, обеспечит процветание их бизнеса. Мы всегда там и в тот момент, где и когда мы необходимы.

## Superstructure



### Boom

11,65 m to 60,0 m seven section TWIN-LOCK™ boom.  
Maximum tip height 63,0 m.



### Boom elevation

1 cylinder with safety valve, boom angle from -1,5° to +82°.



### Load moment and independent anti-two block system

Load moment and independent anti-two block system with audio visual warning and control lever lock-out. These systems provide electronic display of boom angle, length, radius, tip height, relative load moment, maximum permissible load, load indication and warning of impending two-block condition with lock-out hoist function.



### Cab

Aluminium, tiltable (approx. 20°), full vision, safety glass, adjustable operator's seat with suspension, engine-dependent heater. Armrest-integrated crane controls. Ergonomically arranged instrumentation and crane operating controls.



### Slewing

2 slewing gears with axial piston motors, planetary gear, service brake and holding brake.



### Counterweight

11,7 tonnes, consisting of various sections. Hydraulic removal system.



### Engine

Mercedes-Benz OM 904 LA, diesel, 4 cylinders, water cooled, turbocharged, 110 kW (149 HP) at 2200 rpm. (80/1269 EWG - fan rigid). Max. torque : 580 Nm at 1200-1600 rpm. Fuel tank capacity : 185 l.  
Engine emission : EUROMOT / EPA / CARB (non-road).



### Hydraulic system

2 separate circuits, 1 axial piston variable displacement pump (load sensing), with electronic power limiting control and 1 gear pump for slewing. Thermostatically controlled oil cooler. Tank capacity: 600 l.



### Control system

Full electronic control of all crane movements using electrical control levers with automatic reset to zero. Integrated with the LMI and engine management system by CAN-BUS. ECOS system with graphic display.



### Hoist

Axial piston motor with planetary gear and brake. Drum rotation indicator.



### Electrical system

Three-phase alternator 28 V/80 A, 2 batteries 12 V/170 Ah.

### \* Optional equipment

- Bi-fold swingaway, 10/17 m with hydraulic offset and luffing under load (0°-40°), controlled from the crane cab.
- Bi-fold swingaway, 10/17 m (manual offset 0°, 20°, 40°).
- Lattice extension, 22 m - includes 1x5 m fixed non-offsettable section plus 10/17 m swingaway (see above).
- Additional 15,4 tonnes counterweight (total counterweight 27,1 tonnes).
- Auxillary hoist

## Carrier



### Chassis

Special 5-axle chassis, all-welded torsion-resistant box type construction in high strength steel.



### Outriggers

4 hydraulically telescoping beams with vertical cylinders and outrigger pads. Independent horizontal and vertical movement control on each side of the carrier. Electronic level indicator with automatic levelling system



### Engine

Mercedes-Benz OM 502 LA, diesel, 8 cylinders, water cooled, turbocharged, 375 kW at 1800 rpm (80/1269 EWG - fan loose).  
Max. torque: 2400 Nm at 1300 rpm. Fuel tank capacity: 400 l.  
Engine emission: EUROMOT / EPA / CARB Tier 4i (non road).



### Transmission

Mercedes G 240-16 with EPS (Electronic Pneumatic Shifting), 16 forward and 2 reverse speeds. Transverse differential locks. Two speed transfer case with inter-axle differential lock..



### Drive/Steer

10 x 6 x 10.



### Axle lines

5 axle lines. 3, 4 and 5 are driven steering axle lines, the 1st and 2nd are steering axle lines.



### Suspension

MEGATRAK®. All wheels with independent hydropneumatic suspension and hydraulic lockout. Longitudinal and transverse level control with automatic on-highway levelling system. Range +170 mm/-130 mm.



### Tyres

10 tyres, 14.00 R25.



### Steering

Dual circuit, hydraulic power assisted steering with emergency steering pump. Axle lines 1, 2, 3 and 5 steer on highway. Separate steering of the 4th, and 5th axle line for all wheel steering and crabbing.



### Brakes

Service brake: pneumatic dual circuit, acting on all wheels, air dryer. Anti-lock braking system (ABS).  
Permanent brake: exhaust brake and constant throttle brake.  
Parking brake: pneumatically operated spring-loaded brake acting on axle lines 2, 3, 4 and 5.



### Cab

2-man-design, safety glass, driver and passenger seat with hydraulic suspension, engine-dependent hot water heater. Complete instrumentation and driving controls.



### Electrical system

Three-phase alternator 28 V/100A, 2 batteries 12 V/170 Ah. Lighting system and signals 24 V.

### \* Optional equipment

- 10 x 8 x 10.
- Electric driveline retarder.
- 10 tyres, 16.00 R25 (vehicle width 3,00 m).
- 10 tyres, 20.5 R25 (vehicle width 3,10 m).
- Engine-independent hot water heater, with engine pre-heater.
- Engine EUROMOT / EPA / CARB Tier 3 (non road).  
Mercedes-Benz OM 502 LA, 380 kW, max torque: 2400 Nm at 1200 rpm

\*Further optional equipment upon request.

## Kranoberwagen



### Teleskopausleger

Von 11,65 m bis 60,0 m ausfahrbarer, siebenteiliger TWIN-LOCK™ Ausleger. Maximale Rollenhöhe 63,0 m.



### Wippwerk

1 Zylinder mit Sicherheits-Rückschlagventil. Auslegerverstellwinkel -1,5° bis +82°.



### Elektronischer Lastmomentbegrenzer und unabhängiges Hubendschalter System

Elektronischer Lastmomentbegrenzer mit hör- und sichtbarer Vorwarnung sowie automatischer Abschaltung, Digitalanzeige für tatsächliche und zulässige Belastung, Ausladung und diverse Zustände. Unabhängiges Hubendschalter-System mit Abschaltfunktion.



### Krankabine

Aluminium-Kabine, Vollsicht, ca. 20° kippbar, Sicherheitsglas, verstellbarer Fahrersitz mit Dämpfung. In Armlehnen integrierte Kransteuereinrichtung. Ergonomisch angeordnete Steuer- und Kontrolleinrichtungen. Motorabhängige Heizung.



### Drehwerk

2 Drehwerke mit Axialkolbenmotoren, Planetengetriebe, Betriebs- und Haltebremse.



### Gegengewicht

11,7 t bestehend aus mehreren Teilen. Hydraulisches Rüstsystem.



### Motor

Mercedes-Benz OM 904 LA, 4 Zylinder Diesel, wassergekühlt mit Abgasturbolader, 110 kW (149 PS) bei 2200 min<sup>-1</sup> (80/1269 EWG Ventilator starr), max. Drehmoment 580 Nm bei 1200-1600 min<sup>-1</sup>. Kraftstoffbehälter : 185 l. Motoremission : EUROMOT / EPA / CARB (non-road).



### Hydrauliksystem

2 separate Kreisläufe, 1 Axialkolben-Verstellpumpe (Load-Sensing) mit elektronischer Grenzlastregelung und 1 Zahnradpumpe für das Drehwerk. Thermostatisch gesteuerter Ölkühler. Tankvolumen: 600 l Hydrauliköl.



### Steuerung

Voll elektronische Steuerung aller Bewegungen mit elektrischen Kreuzsteuerhebeln mit automatischer Nullstellung, verbunden mit der LMB und dem Motormanagement System über einen CAN-BUS. ECOS System mit grafischer Anzeige.



### Hubwerk

Axialkolbenmotor mit Planetengetriebe und Bremse. Hubwerksdrehmelder.



### Elektrische Anlage

Drehstromlichtmaschine 28 V/80 A, 2 Batterien 12 V/170 Ah.

### \* Zusatzausrüstung

- Doppelklappspitze 10/17 m. Abwinklung (0°- 40°). Aus derKranfahrerkabine hydraulisch einstellbar und unter Teillast wippbar.
- Doppelklappspitze 10/17 m (0°, 20°, 40° manuell abwinkelbar). Auslegerverlängerung.
- Gitterkonstruktion 22 m, bestehend aus 10/17 m Doppelklappspitze (siehe oben) und einem 5 m Verlängerungsstück.
- Zusatzgegengewicht 15,4 t (Gesamtgegengewicht 27,1 t).
- Hilfshubwerk.

## Kranunterwagen



### Rahmen

5-Achs-Spezialfahrzeug, geschweißte, torsionssteife Kastenkonstruktion aus hochfestem Feinkornstahl.



### Abstützung

4 hydraulisch teleskopierbare Schiebeträger mit Abstützylindern und Abstützplatten, beidseitig vom Unterwagen aus einzeln horizontal und vertikal steuerbar. Elektronische Niveauanzeige mit automatischer Nivellierung.



### Motor

Mercedes-Benz OM502LA, 8 Zylinder Diesel, wassergekühlt mit Abgasturbolader, 375 kW bei 1800 min<sup>-1</sup> (80/1269/EWG Ventilator lose), max. Drehmoment 2400 Nm bei 1300 min<sup>-1</sup>. Kraftstoffbehälter: 400 l. Motoremission: EUROMOT / EPA / CARB Tier 4i (non road).



### Getriebe

Mercedes G 240-16 mit EPS (Electronic Pneumatic Shifting), 16 Gänge vorwärts und 2 Gänge rückwärts. Querdifferentialsperren. Verteilergetriebe 2 stufig mit Längsdifferentialsperre..



### Antrieb/Lenkung

10 x 6 x 10.



### Achslinien

5 Achslinien, Achslinie 3, 4 und 5 gelenkt und angetrieben. Achslinie 1 und 2 gelenkt.



### Federung

MEGATRAK®. Alle Räder in Einzelradaufhängung, hydropneumatische Federung und hydraulische Blockierung. Neigungsverstellung in alle Richtungen und automatische Straßenfahrtniveaueinstellung. Federweg +170mm/-130mm.



### Bereifung

10 Reifen, Größe 14.00 R25.



### Lenkung

Zweikreis-Hydraulenklung mit Notlenkpumpe. Während der Straßenfahrt werden die 1., 2., 3. und 5. Achse gelenkt. Separate Lenkung der 4. und 5. Achslinie für Allradlenkung und Krabbengang.



### Bremsen

Betriebsbremse: pneumatische Zweikreisbremse, auf alle Räder wirkend, Lufttrockner. Automatischer Blockier-Verhinderer (ABV). Dauerbremse: Motorklappenbremse mit Konstantdrossel. Feststellbremse: druckluftbetätigte Federspeicherbremse auf 2., 3., 4. und 5. Achslinie



### Fahrerhaus

2-Mann-Fahrerhaus, Sicherheitsglas, hydraulisch gedämpfter Fahrer- und Beifahrersitz, motorabhängige Warmwasserheizung. Kontroll- und Bedienungseinrichtung für Fahrbetrieb.



### Elektrische Anlage

Drehstromlichtmaschine 28 V/100 A, 2 Batterien 12 V/170 Ah, Beleuchtung und Signaleinrichtung 24 V.

### \* Zusatzausrüstung

- 10 x 8 x 10.
- Elektrische Wirbelstrombremse.
- 10 Reifen, Größe 16.00 R25 (Fahrzeugbreite 3,00 m).
- 10 Reifen, Größe 20.5 R25 (Fahrzeugbreite 3,10 m).
- Motorunabhängige Warmwasser-Standheizung mit Motorvorwärmung.
- Motor EUROMOT / EPA / CARB Tier 3 (non road). Mercedes-Benz OM 502 LA, 380 kW, max. Drehmoment 2400 Nm at 1200 mn<sup>-1</sup>.

\*Weitere Zusatzausrüstungen auf Anfrage.

## Superstructure



### Flèche

Flèche sept éléments, de 11,65 m à 60,0 m, à télescopage TWIN-LOCK™. Hauteur maximum de tête de flèche 63,0 m.



### Relevage

1 vérin avec clapet anti-retour, angle de relevage de - 1,5° à +82°.



### Contrôleur d'état de charge et dispositif de fin de course haute crochet indépendant

Équipements électroniques de contrôle de charge et de fin de course haute crochet indépendants avec dispositifs de signalisation sonore et visuelle et de coupure des mouvements. Affichage digital d'angle et de longueur de flèche, de portée, de hauteur de tête de flèche, de moment relatif, de charge maximum autorisée, d'état de charge et d'approche de fin de course haute crochet avec coupure du mouvement de montée de treuil.



### Cabine

Cabine **Aluminium**, inclinable (angle d'inclinaison environ 20°) panoramique, verre de sécurité, siège réglable à suspension, chauffage à eau chaude alimenté par le moteur. Manipulateurs de commandes de grue intégrés aux accoudoirs. Disposition ergonomique de l'instrumentation et des commandes.



### Orientation

2 réducteurs d'orientation avec moteurs à pistons axiaux, frein principal et frein de retenue.



### Contrepoids

Contrepoids modulaire de 11,7 tonnes de poids total et système de dépose hydraulique.



### Moteur

Mercedes-Benz OM 904 LA, diesel, 4 cylindres suralimentés, refroidi par eau et, développant 110 kW (149 CV) à 2200 min<sup>-1</sup>. (80/1269 EWG - Ventilateur en prise directe). Couple maxi : 580 Nm à 1200-1600 min<sup>-1</sup>. Capacité du réservoir : 185 l. Conformité aux normes de pollution : EUROMOT / EPA / CARB (non-road).



### Système hydraulique

Système hydraulique comportant 2 circuits séparés, 1 pompe à pistons axiaux, à débits variables avec dispositif de régulation de puissance électronique et 1 pompe à engrenages pour l'orientation. Refroidisseur d'huile à commande thermostatique. Volume du réservoir : environ 600 l.



### Commande

Commandes de grue électroniques par manipulateurs électriques avec retour au neutre automatique. Ces commandes sont reliées au contrôleur d'état de charge et au dispositif de gestion du moteur thermique par système CAN-BUS. Système ECOS avec affichage graphique.



### Treuil de levage

Treuil avec tambour rainuré, réducteur à planétaires, frein multidisque, moteur à pistons axiaux et indicateur de rotation.



### Installation électrique

Alternateur triphasé 28 V/80 A et 2 batteries 12 V/170 Ah.

### \* Equipements optionnels

- Extension treillis à repliage latéral double de 10/17 m – avec déport hydraulique et inclinaison sous charge (0°-40°) commandés depuis la cabine.
- Extension treillis à repliage latéral double de 10/17 m (inclinable à 0°, 20°, 40°).
- Extension treillis de 22 m constituée de : extension treillis double (voir ci-dessus) plus élément intermédiaire de 5 m.
- Contrepoids supplémentaire de 15,4 t (Contrepoids total 27,1 t).
- Treuil auxiliaire.

## Porteur



### Châssis

Porteur spécial, 5 lignes d'essieux, mécanosoudé, type caisson, en acier à haute limite élastique.



### Calage

4 poutres à télescopage hydraulique, avec vérins et patins d'appui. Commande indépendante des mouvements verticaux et horizontaux sur à niveau électronique les deux côtés du porteur. Indicateur de niveau électronique avec système de mise à niveau automatique.



### Moteur

Moteur Diesel Mercedes-Benz OM502LA, 8 cylindres suralimenté, refroidi par eau et développant 375 kW à 1800 min<sup>-1</sup> (80/1269 EWG - ventilateur débrayable). Couple maxi 2400 Nm à 1300 min<sup>-1</sup>. Capacité du réservoir : env. 400 l. Conformité aux normes de pollution : EUROMOT/EPA/ CARB Tier 4i (tout terrain).



### Boîte de vitesses

Boîte de vitesses Mercedes G 240-16 avec dispositif de gestion automatique des rapports EPS (Electronic Pneumatic Shifting), 16 rapports de marche avant et 2 rapports de marche arrière. Différentiel inter-roues. Boîte de transfert à 2 rapports avec verrouillage longitudinal du différentiel.



### Direction/Transmission

10 x 6 x 10.



### Lignes d'essieux

5 lignes d'essieux. Lignes d'essieux 3, 4, et 5 directrices et motrices, lignes d'essieu 1 et 2 directrices.



### Suspension

Suspension hydropneumatique à roues indépendantes MEGATRAK® et dispositif de verrouillage. Commandes de mise à niveau longitudinal et transversal. Dispositif de mise à niveau automatique en position route. Débattement: +170 mm/-130 mm.



### Pneumatiques

10 pneumatiques 14.00 R25 (385/95 R25).



### Direction

Direction assistée à double circuit et pompe de secours. Lignes d'essieux 1, 2, 3 et 5 directionnelles sur route. Direction indépendante pour les lignes d'essieux 4 et 5 pour réduction du diamètre de braquage et déplacement latéral (marche en crabe).



### Freins

Frein de service pneumatique à double circuit agissant sur toutes les roues. Dessiccateur. Dispositif anti-blocage (ABS). Ralentisseur par clapet sur échappement et décalage de la distribution. Frein de stationnement à ressorts commandé pneumatiquement agissant sur les lignes d'essieux 2, 3, 4 et 5.



### Cabine

Cabine bi-place avec vitrage de sécurité, siège conducteur suspendu, chauffage à eau chaude alimenté par le moteur et instrumentation complète pour le contrôle et la conduite de la machine.



### Installation électrique

Alternateur triphasé 28 V/100 A et 2 batteries 12 V/170 Ah, équipement d'éclairage et de signalisation routière : 24 V.

### \* Equipements optionnels

- Configuration 10 x 8 x10
- Frein électromagnétique.
- 10 pneumatiques 16.00 R25 (largeur du véhicule 3,00 m).
- 10 pneumatiques 20.5 R25 (largeur du véhicule 3,10 m).
- Chauffage auxiliaire à eau chaude indépendant avec dispositif de préchauffage moteur.
- Moteur EUROMOT / EPA / CARB Tier 3 (tout terrain). Mercedes-Benz OM 502 LA, 380 kW, couple maxi : 2400 Nm à 1200 mn<sup>-1</sup>.

\* Autres équipements optionnels sur demande.

# Características

## Superestructura



### Pluma

De 11,65 m a 60,0 m siete secciones tramos de telescopaje TWIN-LOCK™. Altura máxima en punta 63,0 m.



### Elevación de pluma

Un cilindro con válvula de seguridad. Angulo de pluma desde -1,5° hasta +82°.



### Sistema Indicador del Momento de Carga y de Final de Carrera del Gancho

Sistema indicador del momento de carga y de final de carrera del gancho, con alarma audio-visual y bloqueo automático de las palancas. Este sistema incluye pantalla digital con indicación de ángulo de pluma, longitud, radio, altura de cabeza de pluma, momento de carga relativo, carga máxima permisible, carga real y alarma de fin de carrera del gancho con bloqueo del movimiento de elevación.



### Cabina

De **Aluminio** basculable (approx. 20°) amplia visibilidad, cristales de seguridad, asiento del operador ajustable y con suspensión. Calefacción dependiente del motor por agua caliente. Controles de la grúa integrados en el apoya-brazos. Controles de operación de la grúa e instrumentación ergonómicamente situados.



### Giro

2 reductores de giro con motores de piston axial, engranaje planetario, freno de servicio y freno de retención.



### Contrapeso

De 11,7 Tm., compuesto de varios bloques. Sistema hidráulico para desmontaje.



### Motor

Diesel Mercedes-Benz OM 904 LA, 4 cilindros, refrigerado por agua, turboalimentado, 110 kW (149 HP) a 2200 r.p.m. (80/1269 EWG - ventilador fijo). Par máximo : 580 Nm at 1200-1600 r.p.m. Capacidad del depósito de combustible : 185 l. Emisión de gases : Según normas EUROMOT / EPA / CARB (fuera de carretera).



### Sistema hidráulico

2 circuitos separados, 1 bomba variable de desplazamiento con pistones axiales (con sensor de carga), con control electrónico de limitación de potencia y 1 bomba de doble marcha para la rotación. Refrigerador del aceite controlado por termostato. Capacidad del depósito: 915 l.



### Sistema de control

Control completamente electrónico de todos los movimientos de la grúa, usando palancas de control eléctrico con retorno automático a cero. Integrado con el Limitador de Cargas y el sistema de control del motor por un equipo "CAN-BUS". Sistema ECOS con pantalla gráfica.



### Cabrestante

Motor de pistón axial con engranaje planetario y freno. Indicador de rotación del tambor.



### Sistema eléctrico

Trifásico con alternador 28V/80A, dos baterías de 12v/170 Ah.

### \* Equipos opcionales

- Plumín articulado en 2 secciones, 10/17 m - con angulación fija y variable, con carga (0° - 40°) de accionamiento hidráulico.
- Plumín articulado en 2 secciones, 10/17 m (angulable 0°, 20°, 40°).
- Extensión de pluma, de celosía de 22 m, incluyendo el plumín de 10/17 m (el de arriba) más extensiones de 5m.
- Contrapeso adicional de 15,4 Tm. (Contrapeso total 27,1 Tm).
- Cabrestante Auxiliar.

## Chasis



### Bastidor

Chasis especial de cinco ejes de construcción soldada tipo cajón, resistente a la torsión, en acero de alta resistencia.



### Estabilizadores

Cuatro vigas telescópicas hidráulicas con cilindros verticales y placas de apoyo. Controles independientes para los movimientos horizontales y verticales, con controles en ambos lados del chasis. Indicador electrónico de nivel con sistema de nivelación automática.



### Motor

Diesel Mercedes Benz OM502LA, 8 cilindros, refrigerado por agua y turboalimentado, 375 Kw a 1.800 r.p.m. (80/1269 EWG - ventilador desconectado), par máximo: 2400 Nm, a 1.300 r.p.m. Capacidad del depósito de Combustible: 400 litros. Emisión de gases: Según normas EUROMOT / EPA / CARB Tier 4i(fuera de carretera).



### Transmisión

Mercedes G 240-16 más EPS (Electronic Pneumatic Shifting), 16 velocidades delante y 2 atrás. Candado de diferencial. Caja de transferencia de 2 velocidades con bloqueo de diferencial entre ejes.



### Tracción/Dirección

10 x 6 x 10.



### Ejes

5 ejes en línea. Ejes 3, 4 y 5 motrices y directrices. Eje 1 y 2 directrices.



### Suspensión

MEGATRAK®. Todas las ruedas con suspensión hidroneumática independiente y bloqueo hidráulico. Control de nivel longitudinal y transversal con sistema de nivelación automática en carretera. Desplazamiento +170 mm./ -130 mm.



### Neumáticos

10 neumáticos, 14.00 R25.



### Dirección

Dirección servo-asistida con doble circuito con bomba de dirección de emergencia. Los ejes 1, 2, 3 y 5 son directrices para circular por carretera. Dirección separada de los ejes 4 y 5 para la dirección en todas las ruedas y conducción tipo cangrejo.



### Frenos

Frenos de servicio: Neumático con doble circuito, actuando sobre todas las ruedas, secador de aire. Sistema antibloqueo de frenos (ABS).

Freno continuo: Freno sobre el escape, con estrangulamiento continuo.

Freno de aparcamiento: Operado neumáticamente y aplicado por muelle sobre los ejes 2°, 3°, 4° y 5°.



### Cabina

Para dos personas, cristales de seguridad, asientos del conductor y pasajero con suspensión hidráulica, calefacción por agua caliente del motor. Controles e instrumentación para conducción del vehículo.



### Sistema eléctrico

Trifásico, alternador de 28 V/100A, 2 baterías 12 V/170 Ah. Sistema de alumbrado y señalización a 24 V.

### \* Equipos opcionales

- 10 x 8 x 10.
- Retardador eléctrico.
- 10 neumáticos 16.00 R25 (Anchura del vehículo: 3,00 m).
- 10 neumáticos 20.5 R25 (Anchura del vehículo: 3,10 m).
- Calefacción independiente del motor por agua caliente, con precalentamiento del motor.
- Motor EUROMOT / EPA / CARB Tier 3 (fuera de carretera). Mercedes-Benz OM 502 LA, 380 kW. Par máximo : 2400 Nm at 1200 r.p.m.

\* Sigüientes equipos bajo demanda.

## Torretta



### Braccio

A sette sezioni da 11,65 a 60,0 m con sfilamento TWIN-LOCK™. Altezza massima: 63,0 m.



### Sollevamento Braccio

Un cilindro con valvola di sicurezza, angolo del braccio da -1,5° a +82°.



### Limitatore di carico e blocco dei movimenti

Limitatore di carico e finecorsa con allarme visivo e sonoro e blocco delle leve di comando. Questo sistema è provvisto di display elettronico riportante l'angolo e la lunghezza del braccio, il raggio di lavoro, l'altezza di lavoro, il momento, il carico massimo ammissibile e il carico sollevato. Allarme per prevenire il fine corsa con blocco delle funzioni dell'argano.



### Cabina

Costruita in alluminio, grande visibilità, ribaltabile (circa 20°) cristalli di sicurezza, sedile regolabile con sospensione. Riscaldamento ad acqua dipendente dal motore. Comandi della gru integrati nei braccioli, strumentazione di controllo e servizio.



### Rotazione

2 motoriduttori di rotazione a pistoni assiali, riduttore planetario, freno di servizio e freno d'arresto.



### Contrappeso

11,7 tonnellate, in più sezioni. Sistema di rimozione idraulico.



### Motore

Mercedes-Benz OM 904 LA, diesel, 4 cilindri turbocharged, 110 kW (149 HP) at 2200 giri/min. (80/1269 EWG - ventola rigida). Coppia max : 580 Nm at 1200-1600 giri/min. Capacità serbatoio : 185 l.

Emissioni gassose allo scarico : EUROMOT / EPA / CARB (no su strada).



### Impianto idraulico

Due circuiti separati, una pompa a pistoni assiali a portata variabile con limitatore elettronico (load sensing) e una pompa a ingranaggi per la rotazione.

Raffreddamento olio idraulico con controllo termostatico.

Capacità serbatoio 600 litri.



### Comandi

Controllo completamente elettronico di tutti i movimenti della gru con leve di comando a controllo elettrico con azzeramento automatico. Integrato con il sistema LMI (Limitatore di carico) e con il sistema CAN-BUS di controllo del motore.



### Argano

Motore a pistoni assiali a portata variabile con riduttore planetario e freno. Indicatore della rotazione dell'argano.



### Impianto elettrico

Alternatore trifase 28V/80 A, due batterie 12V 170Ah.

### \* Accessori opzionali

- Prolunga tralicciata pieghevole 10/17 m, con sistema di posizionamento idraulico e angolazione sotto carico (0°-40°), controllata dalla cabina gru.
- Falcone ripiegabile da 10/17 m inclinabile a 0°, 20°, 40°.
- Prolunga tralicciata 22 m inclusi 5 metri fissi non angolabili, più prolunga tralicciata 10/17 m (vedi sopra).
- Contrappeso aggiuntivo di 15,4 tonnellate (contrappeso totale 27,1 tonnellate).
- Argano ausiliario

## Carro



### Telaio

Telaio speciale 5 assi, completamente saldato, in acciaio sciolato ad alta resistenza, resistente alla torsione.



### Stabilizzatori

4 travi orizzontali telescopiche con cilindri verticali e piatti stabilizzatori. Controllo dei movimenti verticale ed orizzontale indipendente su ogni lato del carro. Indicatori elettronici di livello con sistema di messa in bolla automatico.



### Motore

Mercedes Benz OM502LA diesel 8 cilindri raffreddato ad acqua, sovralimentato, potenza di 375 kW a 1800 giri (80/1269 EWG fan loose).

Coppia massima 2400 Nm a 1300 giri. Capacità serbatoio 400 litri.

Emissione gassosa allo scarico nei limiti: EUROMOT / EPA / CARB Tier 4i (motori non stradali).



### Cambio

Mercedes G 240-16 con EPS (Electronic Pneumatic Shifting) 16 velocità avanti più 2 retromarcia. Bloccaggio differenziale trasversale. Riduttore ripartitore a 2 velocità.



### Trazione/Sterzo

10 x 6 x 10.



### Assali

5 assi: 5 assali sterzanti, assali motori terzo, quarto e quinto.



### Sospensioni

MEGATRAK®. Tutte le ruote sono montate su sospensioni idropneumatiche indipendenti con bloccaggio idraulico. Controllo del livellamento longitudinale e trasversale con livellamento automatico per la circolazione stradale.

Corsa +170mm/-130mm.



### Pneumatici

10 pneumatici montati in singolo 14.00 R25.



### Sterzo

Doppio circuito, Servoassistito idraulicamente con pompa di emergenza. Assi 1 2 3 e 5 comandati dallo sterzo durante la guida. Comando separato per il quarto e il quinto asse per eseguire la sterzata combinata e a granchio.



### Freni

Freno di servizio: pneumatico a doppio circuito, agente su tutte le ruote, con essiccatore aria. Sistema frenante antiblocco (ABS). Freno di stazionamento: scarico frenato e controllo costante valvola. Freno di parcheggio: con molle precaricate a comando pneumatico agente sugli assi 2,3,4 e 5.



### Cabina

Due posti, cristalli di sicurezza, sedile autista e passeggero con sospensione idraulica, riscaldamento a ricircolo con il liquido di raffreddamento motore. Completa strumentazione di controllo e guida.



### Impianto elettrico

Alternatore trifase 28V/100 A, 2 batterie 12V 170Ah. Luci e segnali a 24 V.

### \* Accessori opzionali

- 10x8x10.
- Retarder elettrico.
- 10 pneumatici 16.00 R25 (larghezza veicolo 3,00 metri)
- 10 pneumatici 20.5 R25 (larghezza veicolo >3,00 metri)
- Riscaldamento autonomo con preriscaldatore motore.
- Motore EUROMOT / EPA / CARB Tier 3 (motori non stradali). Mercedes-Benz OM 502 LA, 380 kW. Coppia massima 2400 Nm a 1200 giri.

\* Altri a richiesta.

# Технические характеристики

## Крановая установка



### Стрела

Шестисекционная стрела TWIN-LOCK™ 11,65 - 60,0 м.  
Максимальная высота оголовка стрелы 63,0 м.



### Подъем стрелы

1 цилиндр с предохранительным клапаном, угол подъема от -1,5° до +82°.



### Ограничитель грузовой момент и независимая система блокировки при переподъеме

Ограничитель грузовой момент и независимая система блокировки при переподъеме с звуковой и визуальной сигнализацией и блокировкой рычагов управления. Эти системы выводят на электронный дисплей угол наклона стрелы, длину, радиус, высоту оголовка стрелы, относительный грузовой момент, максимально допустимую нагрузку, текущую нагрузку и предупреждение о возможности перегруза, которое повлечет за собой блокировку управления краном.



### Кабина

Кабина: **алюминий**, с круговым обзором, наклоняемая (примерно 20°), бесколочное стекло, регулируемое место оператора с подвеской, устройство для обогрева водой с подогревом от двигателя. Органы управления краном встроены в подлокотник. Эргономичная приборная панель и система управления краном.



### Поворот

2 поворотных механизма с аксиально-поршневыми моторами постоянного рабочего объема, планетарной передачей, эксплуатационным и стопорным тормозами.



### Противовес

11,7 тонн, состоит из различных секций. Гидравлическая система монтажа противовесов.



### Двигатель

Mercedes-Benz OM906LA, дизельный, 4-цилиндровый, с водяным охлаждением, с турбонагнетателем, 110 кВт (149 л. с.) при 2200 об/мин. (80/1269 EWG - вентилятор без возможности замены). Макс. крутящий момент: 580 Нм при 1200–1600 об/мин. Емкость топливного бака: 185 л. Выбросы двигателя: EUROMOT/EPA/CARB (не дорожный).



### Гидравлическая система

2 раздельных контура, 1 аксиально-поршневой насос с переменным рабочим объемом (в зависимости от нагрузки), с электронным ограничителем мощности и 1 шестеренчатый насос для поворота крана. Охладитель масла, регулируемый с помощью термореле. Емкость бака: 600 л.



### Система управления

Полностью электронная система управления движением крана с электрорычагами управления и с автоматическим возвратом в нейтральное положение. Эта система соединена с локальным интерфейсом управления и системой управления работой двигателя при помощи шины CAN-BUS. Система ECOS снабжена графическим дисплеем.



### Лебедка основного подъема

Аксиально-поршневой гидромотор с планетарной передачей и тормозом. Индикатор вращения барабана.



### Электросистема

Трехфазный генератор переменного тока 28 В/80 А, 2 батареи 12 В/170 А-ч.

### \* Дополнительное оборудование (по выбору)

- Складной удлинитель стрелы, 10/17 м с гидравлическим регулированием вылета стрелы и возможностью управления под нагрузкой (0°-40°), управляемый из кабины оператора.
- Складной удлинитель стрелы, 10/17 м (регулирование вручную 0°, 20°, 40°).
- Гусек, 22 м - включая промежуточную секцию (1 x 5 м) и складной удлинитель стрелы 10/17 м (см. выше).
- Дополнительный противовес 15,4 т (суммарная масса противовеса 27,1 т).
- Лебедка вспомогательного подъема

## Тягач



### Шасси

Специальное 5-осное шасси: цельносварное, устойчивое к кручению, коробчатого типа, выполненное из высокопрочной стали.



### Выносные опоры

4 двойные балки с гидравлическим способом телескопирования с вертикальными цилиндрами и основаниями выносных опор. Независимый контроль горизонтального и вертикального передвижения с каждой стороны тягача и из кабины оператора. Электронный индикатор уровня с автоматической системой выравнивания. Рабочее освещение каждой выносной опоры.



### Двигатель

Mercedes-Benz OM502LA, дизельный, 8-цилиндровый, с водяным охлаждением, с турбонагнетателем, 375 кВт при 1800 об/мин. (80/1269 EWG - сменный вентилятор). Макс. крутящий момент: 2400 Нм при 1300 об/мин. Емкость топливного бака: 400 л.



### Трансмиссия

Mercedes G 240-16 с с электронным пневматическим переключением (EPS), 16 скоростей переднего хода и 2 – заднего. Поперечная блокировка дифференциала. Двухступенчатая раздаточная коробка с межосевым механизмом блокировки дифференциала.



### Ведущие / Управляемые оси

10 x 6 x 10.



### Оси

5 осей. 3, 4 и 5 - ведомые управляемые оси (оси управления поворотом), 1 и 2 - управляемые оси.



### Подвеска

MEGATRAK®. Подвеска всех колес гидропневматическая с гидравлической блокировкой. Контроль продольного и поперечного уровня с автоматической системой выравнивания на дороге. Диапазон +170 мм/-130 мм.



### Шины

10 tyres, 14,00 R25.



### Рулевое управление

Двухконтурная гидравлическая схема управления поворотами с аварийным насосом системы управления. Оси 1, 2, 3 и 5 управляют движением по шоссе. Отдельное управление осями 4 и 5 для полноприводного движения и крабового хода.



### Тормоза

Рабочая тормозная система: пневматическая двухконтурная, с работой на все колеса, осушитель воздуха. Антиблокировочная система торможения (ABS). Постоянный тормоз: приспособление для дросселирования выхлопа при торможении двигателем и постоянный дроссельный тормоз.



### Кабина

двухместная, бесколочное стекло, сиденья водителя и пассажира с гидравлической подвеской, независимое от двигателя устройство подогрева горячей водой. Полная система управления и приборная панель.



### Электросистема

Электросистема

Трехфазный генератор переменного тока 28 В/100А, 2 батареи 12 В/170 А-ч. Система освещения и сигнализации 24 В.

### \* Дополнительное оборудование (по выбору)

- 10x8x10.
- Электромагнитный замедлитель трансмиссии.
- 10 шин, 16,00 R25 (ширина крана 3,00 м).
- 10 шин, 20,5 R25 (ширина крана 3,10 м).
- Независимое от двигателя устройство для обогрева горячей водой с предварительным нагревом от двигателя.
- EUROMOT / EPA / CARB Tier 4i (не дорожный). Mercedes-Benz OM 502 LA, 380 kW. Макс. крутящий момент: 2400 Нм при 1200 об/мин.

\* Прочее дополнительное оборудование предоставляется по запросу.





# Data • Daten • Caractéristiques • Datos • Dati • Данные



Axle • Achse Essieu • Eje Asse • Оси	1	2	3	4	5	Total weight • Gesamtgewicht Poids total • Peso total Peso totale • Суммарный вес
t	12	12	12	12	12	60 *

\* with 11,7 t counterweight, 10x8x10, 16.00 R25 tyres, 10/17 m bi-fold swingaway, 40 t Hookblock / 13,9 t Gegengewicht, 10x6x10, 14.00 R25 tyres, 10/17 m bi-fold swingaway, 20 t Hookblock  
 \* mit 11,7 t Gegengewicht, 10x8x10, 16.00 R25 Reifen, 10/17 m Doppelklappspitze, 40 t Hakenflasche / 13,9 t Gegengewicht, 10x6x10, 14.00 R25 Reifen, 10/17 m Doppelklappspitze, 20 t Hakenflasche  
 \* avec contrepoids de 11,7 t, 10x8x10, pneus, 16.00 R25, extension treillis 10/17m, 40t moufle / contrepoids de 13,9 t, 10x6x10, pneus, 14.00 R25, extension treillis 10/17m, 20 t moufle  
 \* con 11,7 t contrapeso, 10x8x10, neumáticos 16.00 R25, 10/17 m plumin articulado, gancho de 40 t / 13,9 t contrapeso, 10x6x10, neumáticos 14.00 R25, 10/17 m plumin articulado, gancho de 20 t  
 \* con a bordo 11,7 t di zavorra, 10x8x10, Gomme tipo 16.00 R25, falcone ripiegabile da 10/17 m, gancio da 40 t / a bordo 13,9 t di zavorra, 10x6x10, Gomme tipo 14.00 R25, falcone ripiegabile da 10/17 m, gancio da 20 t  
 \* с противовесом 11,7 т, 10x8x10, шинами 16,00 R25, складным удлинителем стрелы 10/17 м, крюковым блоком 40 т, с противовесом 13,9 т, 10x6x10, шинами 14,00 R25, складным удлинителем стрелы 10/17 м, крюковым блоком 20 т



Lifting Capacity Traglast Force de levage Capacidad de elevación Capacità di sollevamento Грузоподъемность	Sheaves Rollen Poules Poleas Carrucole Шкивы	Weight Gewicht Poids Peso Peso Масса	Parts of line Stränge Brins Ramales de cable Numero di funi Кратность запасовки	Possible load with crane* Mögliche Traglast am Kran* Capacité possible sur la grue* Carga posible con la grue* Portata ammissibile con la gru* Допустимая нагрузка для крана*
100 t	7	1000 kg	2 - 15	82 t
63 t	5	750 kg	2 - 11	61 t
40 t	3	550 kg	1 - 7	39 t
20 t	1	300 kg	1 - 3	17 t
8 t	H/B	200 kg	1	5,7 t

\* Varies depending on national regulations • Variiert je nach Ländvorschrift • Fonction des réglementations nationales • Variaciones dependiendo de las regulaciones nacionales • Varia in funzione delle normative nazionali • изменяется в зависимости от национальных норм

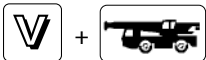

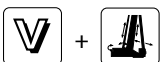

	1	2	3	4	5	6	7	8	9	10	11	12	13	14	15	16	R1	R2		
km/h	5,7	6,9	8,5	10,2	12,8	15,4	18,6	22,4	25,4	30,5	37,6	45,3	56,2	67,7	78,1	85	6,3	7,6		
km/h	2,6	3,1	3,9	4,6	5,8	6,9	8,4	10,1	11,4	13,8	16,9	20,4	25,4	30,6	36,9	44,5	2,9	3,5	71%	
	14.00 R25																			

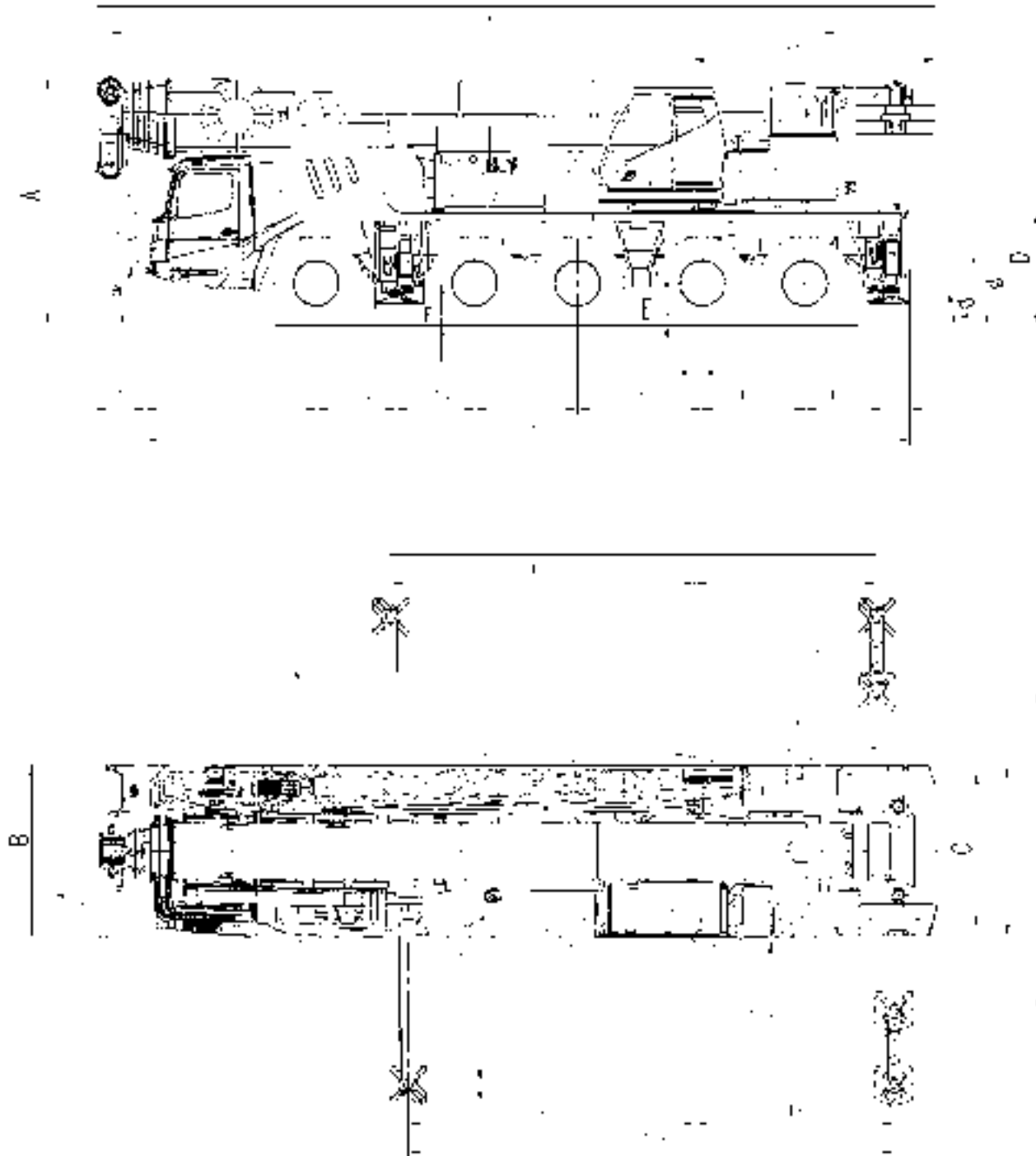

	Infinitely variable • Stufenlos Progressivement variable Infinitamente variable • Infinitamente variabile Плавно-изменяемый	Rope • Seil Câble Cable • Fune Канат	Max. Single line pull • Max. Seilzug Effort maxi au brin simple Tiro máximo por ramal • Tiro max. per singola fune Макс. натяжение каната
	0 - 120 m/min Single line • Einfacher Strang Brin simple • Ramal simple • Tiro a fune singola • Однократная запасовка	17 mm / 255 m	56,0 kN
	0 - 120 m/min Single line • Einfacher Strang Brin simple • Ramal simple • Tiro a fune singola • Однократная запасовка	17 mm / 255 m	56,0 kN
	0 - 1,9 min <sup>-1</sup>		
	-1,5° to + 82° < 50 s		
	11,65 to 60,0 m < 480 s		

Dimensions • Abmessungen • Encombrement  
Dimensiones • Dimensioni • Размеры



	A	A 130 mm*	B	C	D	E	F	$\alpha$	$\beta$	$\beta_1$
14.00 R25	3945	3815	2750	2338	1750	435	356	18	23	17
16.00 R25	3995	3865	3000	2486	1800	485	386	20	25	19
20.5 R25	3995	3865	3000	2507	1800	485	386	20	25	19

Ra = Radius all wheels steered  
 Radius allradgelenkt  
 Rayon toutes les roues directrices  
 Radio de giro con todas las ruedas giradas  
 Raggio di curva con tutte le ruote sterzate  
 Радиус поворота при управлении всеми колесами

\* Lowered  
 Abgesenkt  
 Surbaissée  
 Abbassato  
 Rebaja  
 Сниженный

**Dimensions • Abmessungen • Encombrement**  
**Dimensiones • Dimensioni • Размеры**

Counterweight • Gegengewicht • Contrepoids • Contrapesos • Contrappesi • Противовес

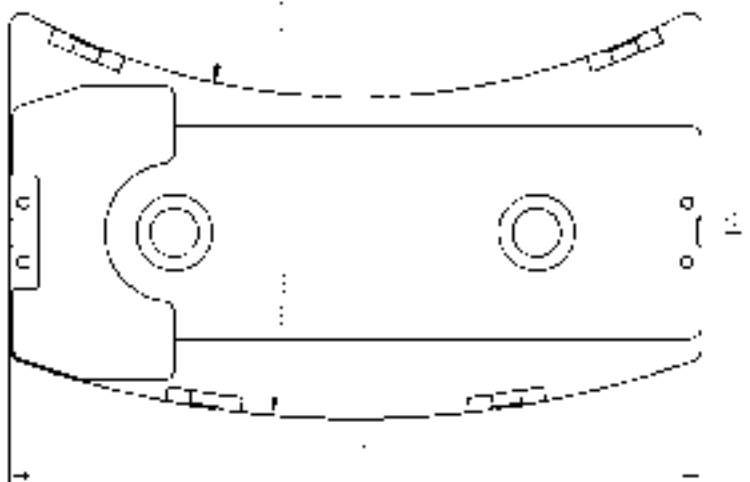
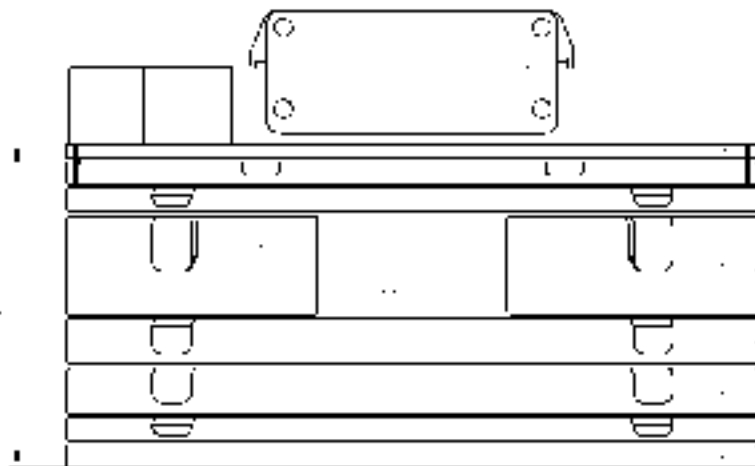

	① 0,6 t	② 2,3 t	③ 2,2 t	④ 2,2 t	⑤ 3,3 t	⑥ 3,3 t	⑦ 4,4 t	⑧ 2,2 t
<b>5,1 t</b>	x	x	x	-	-	-	-	-
<b>7,3 t</b>	x	x	x	-	-	-	-	x
<b>9,5 t</b>	x	x	x	x	-	-	-	x
<b>11,7 t</b>	x	x	x	-	-	-	x	x
<b>13,9 t</b>	x	x	x	x	-	-	x	x
<b>16,1 t</b>	x	x	x	x	x	x	-	x
<b>18,3 t</b>	x	x	x	-	x	x	x	x
<b>20,5 t</b>	x	x	x	x	x	x	x	x
<b>22,7 t</b>	x	x	x	-	x	x	2x	x
<b>24,9 t</b>	x	x	x	x	x	x	2x	x
<b>27,1 t</b>	x	x	x	2x	x	x	2x	x

# Dimensions • Abmessungen • Encombrement Dimensiones • Dimensioni • Размеры

Counterweight • Gegengewicht • Contrepoids • Contrapesos • Contrappesi • Противовес

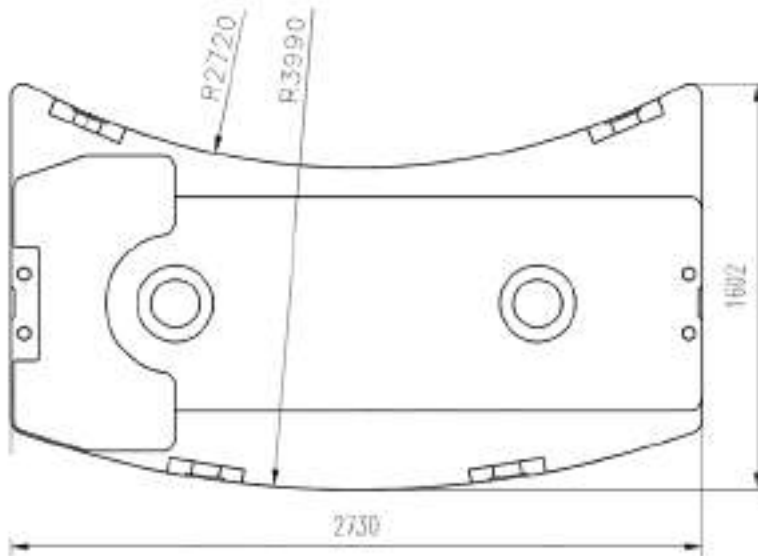
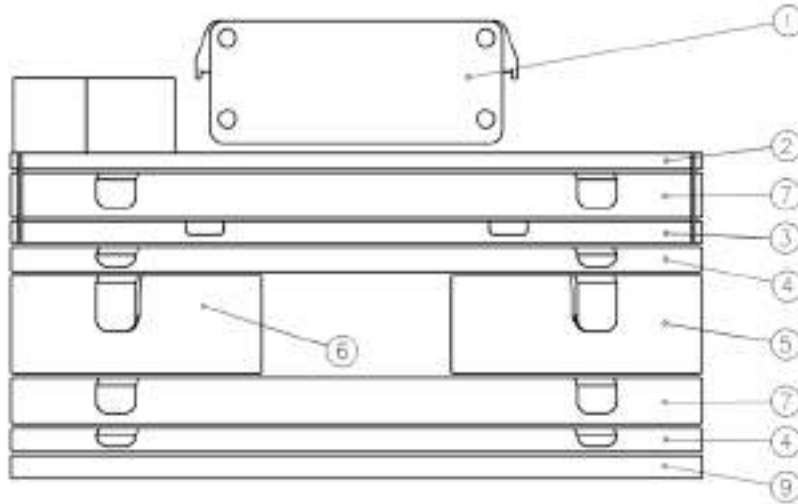

	① 0,6 t	② 2,3 t	③ 2,2 t	④ 2,2 t	⑤ 3,3 t	⑥ 3,3 t	⑦ 4,4 t	⑨ 2,2 t
<b>9,5 t</b>	x	x	x	-	-	-	x	-
<b>11,7 t</b>	x	x	x	-	-	-	x	x
<b>13,9 t</b>	x	x	x	x	-	-	x	x
<b>16,1 t</b>	x	x	x	-	-	-	2 x	x
<b>18,3</b>	x	x	x	-	x	x	x	x
<b>20,5 t</b>	x	x	x	x	x	x	x	x
<b>22,7 t</b>	x	x	x	2 x	x	x	x	x
<b>24,9 t</b>	x	x	x	x	x	x	2 x	x
<b>27,1 t</b>	x	x	x	2 x	x	x	2 x	x

\* Special option • Wahlweise • Option spéciale • Opción especial • Equipaggiamento speciale (UK-Version) • Спецзаказ

# Load charts • Traglasten • Capacités de levage Capacidades • Capacità • Таблицы грузоподъемности

Notes • Hinweise • Notes • Notas • Note • Примечания

## The lifting capacities correspond to EN 13000:2004.

The lifting capacities likewise fulfil the requirements of ISO 4305 and DIN 15019, Part 2, with regard to stability, and DIN 15018, Part 3, and FEM 5004 with regard to strength.

The lifting capacities are given in tonnes.

Lifting capacity = Payload + weight of hook block and suspending device.

The lifting capacities for the main boom only apply with the jib dismantled.

Lifting capacities > 77 t require additional equipment.

Lifting capacities > 85 t require special equipment.

The right is reserved to modify the load-carrying capacities.

**Note: The details in this brochure serve only as general information. The determinant values for the operation of the crane are the lifting capacity tables belonging to it and the operating instructions.**

## Die Tragfähigkeiten entsprechen EN 13000:2004.

Die Tragfähigkeitswerte erfüllen ebenfalls die Anforderungen von ISO 4305 und DIN 15019 Teil 2 bezüglich Standsicherheit sowie von DIN 15018 Teil 3 und FEM 5004 bezüglich Festigkeit.

Die Tragfähigkeitswerte sind in Tonnen angegeben.

Tragfähigkeit = Nutzlast + Gewicht der Hakenflasche und Anschlagmittel.

Die Tragfähigkeitswerte für den Hauptausleger gelten nur bei demontierten Spitzenauslegern.

Die Tragfähigkeitswerte > 77 t erfordern eine Zusatzausrüstung.

Die Tragfähigkeitswerte > 85 t erfordern eine Sonderausrüstung.

Änderung der Tragfähigkeiten vorbehalten.

**Anmerkung: Die Daten dieser Broschüre dienen nur zur allgemeinen Information. Maßgebend für den Betrieb des Kranes sind die zugehörigen Tragfähigkeitstabellen und die Bedienungsanleitung.**

## Les capacités de levage sont conformes à la norme EN 13000:2004.

Les capacités de levage respectent également les exigences des normes ISO 4305 et DIN 15019, paragraphe 2, relatives à la stabilité, ainsi que celles des normes DIN 15018 paragraphe 3 et FEM 5004 relatives à la résistance.

Les capacités de levage sont exprimées en tonnes.

Capacité = charge utile + poids du crochet et du dispositif d'élingage.

Les capacités de levage de la flèche principale ne sont valables que lorsque la fléchette est démontée.

Des capacités de levage > 77 tonnes exigent l'utilisation d'un dispositif supplémentaire.

Des capacités de levage > 85 tonnes exigent l'utilisation d'un dispositif spécial.

Le constructeur se réserve le droit d'apporter des modifications à ces capacités de levage.

**Remarque : Les données de cette brochure ne sont fournies qu'à titre d'information générale. La manipulation de la grue nécessite l'étude des tableaux de capacité et la lecture des guides d'utilisation correspondants.**

## Las capacidades de carga corresponden a EN 13000:2004.

Asimismo los valores de carga cumplen las disposiciones de las normas ISO 4305 y DIN 15019, 2.ª parte, respecto a la estabilidad, y DIN 15018, 3.ª parte, y FEM 5004 respecto a la fuerza.

Los valores de carga se dan en toneladas.

Capacidad de carga = Carga + peso de la garrucha del gancho y del mecanismo de elevación.

Los valores de carga para la pluma principal sólo son válidos cuando no hay plumines instalados.

Valores de carga > 77 t requieren un mecanismo de elevación suplementario.

Valores de carga > 85 t requieren una unidad especial.

Se reserva el derecho a modificar las capacidades de carga.

**Nota: Los detalles contenidos en este folleto sirven sólo como información general. Los valores determinantes para el funcionamiento de la grúa son los cuadros de cargas correspondientes, así como las instrucciones de funcionamiento.**

## Le tabelle di portata sono conformi alle norme EN 13000:2004.

I valori delle tabelle di portata sono conformi anche ai requisiti delle norme ISO 4305 e DIN 15019, Parte 2, per quanto riguarda la stabilità, ed alle norme DIN 15018, Parte 3, e FEM 5004 per quanto riguarda il calcolo di resistenza della struttura.

I valori di portata sono indicati in tonnellate.

Capacità di portata = carico utile + peso del gancio e accessori di sollevamento.

I valori delle tabelle di portata per il braccio principale si applicano solo con le punte bracci smontate.

Valori di portata > 77 t richiedono un'attrezzatura supplementare.

Valori di portata > 85 t richiedono un'unità speciale.

Si riserva il diritto di modificare i valori di portata.

**Nota: i dettagli forniti nel presente opuscolo servono solo come informazioni di carattere generale. I valori determinanti per il funzionamento della gru sono le tabelle di portata appartenenti alla gru stessa e le istruzioni di funzionamento.**

## Грузоподъемность соответствует EN 13000:2004.

Кроме того, грузоподъемность удовлетворяет требованиям ISO 4305 и DIN 15019 (часть 2) в отношении устойчивости, и DIN 15018, (часть 3), и FEM 5004 в отношении прочности материала.

Грузоподъемность приведена в тоннах.

Грузоподъемность = Полезный груз + вес крюкового блока и устройства для подвешивания.

Грузоподъемность основной стрелы только при сложенном удлинителе.

Грузоподъемность > 77 т необходимо дополнительное оборудование.

Грузоподъемность > 85 т необходимо специальное оборудование.

Оставляем за собой право изменять грузоподъемность.

**Примечание: В данной брошюре приведена только общая информация. Рабочие значения для крана приведены в таблицах грузоподъемности (см. данную брошюру и инструкции по эксплуатации).**

# Load charts • Traglasten • Capacités de levage Capacidades • Capacità • Таблицы грузоподъемности

Working range • Arbeitsbereiche • Diagramme de levage • Gama de trabajo • Area di lavoro • Грузовысотные характеристики



11,65 - 60,0 m



0°-40°  
10,0 - 17,0 - 22,0 m



7,0 m



360°

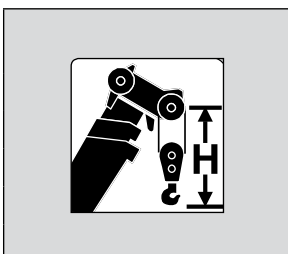
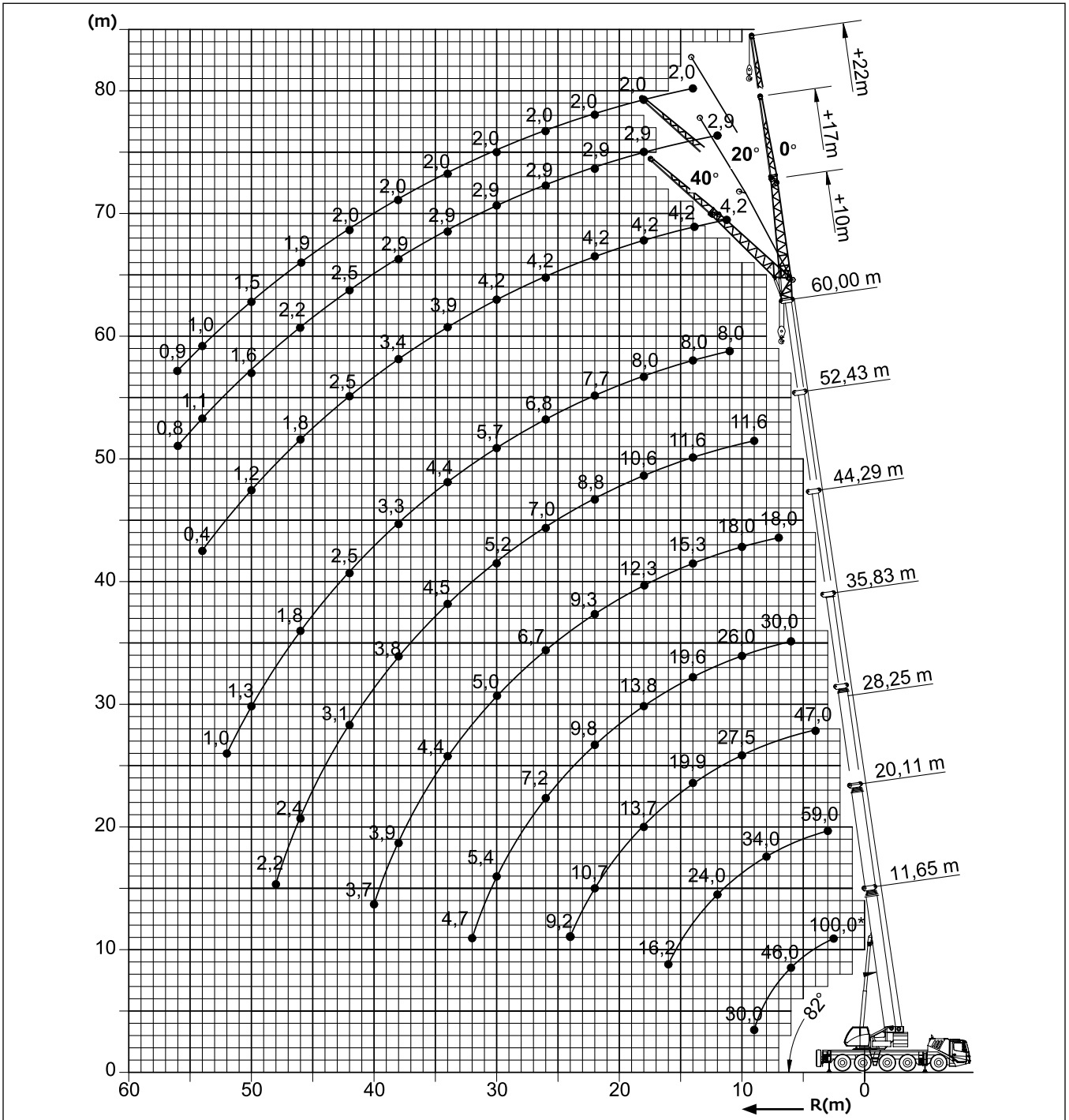

Hook block • Hakenflasche • Crochet-moufle • Gancho • Ganci • Крюковой блок (t)

Hook block (t)	H (mm)
100 D	3100
63 E/D	3000
40 E/D	2900
20 E/D	2800
8 H/B	2350









# Load charts • Traglasten • Capacités de levage Capacidades • Capacità • Таблицы грузоподъемности

**Telescopic boom • Teleskopausleger • Flèche principale • Pluma telescópica • Braccio telescopico • Телескопическая стрела**

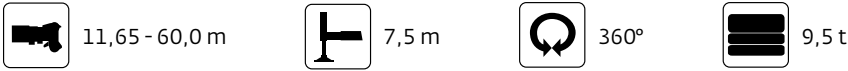

m	11,65	15,90	20,11	24,26	28,25	32,11	35,83	40,08	44,29	48,43	52,43	56,28	60,00	m
3,0	69,0	63,5	59,0	56,0	-	-	-	-	-	-	-	-	-	3,0
4,0	59,0	56,0	52,5	49,5	47,0	-	-	-	-	-	-	-	-	4,0
5,0	52,0	49,5	47,0	44,5	41,5	37,5	-	-	-	-	-	-	-	5,0
6,0	44,5	44,0	41,5	40,5	38,0	36,5	30,0	23,0	-	-	-	-	-	6,0
7,0	37,0	38,0	37,0	35,5	34,0	31,5	30,0	23,0	18,0	-	-	-	-	7,0
8,0	31,5	32,0	31,5	29,0	28,5	28,0	26,0	23,0	18,0	14,3	-	-	-	8,0
9,0	26,0	27,5	26,5	26,0	24,5	24,5	22,5	21,0	18,0	14,3	11,6	-	-	9,0
10,0	-	22,5	23,0	22,5	22,0	21,0	19,5	18,1	17,2	14,3	11,6	9,5	-	10,0
11,0	-	19,1	19,8	19,7	19,8	18,6	17,1	16,8	15,0	14,3	11,6	9,5	8,0	11,0
12,0	-	16,4	17,0	17,1	17,6	16,4	15,2	15,2	13,2	12,8	11,6	9,5	8,0	12,0
13,0	-	14,2	14,8	15,7	15,6	14,6	14,5	13,5	11,6	11,3	11,2	9,5	8,0	13,0
14,0	-	-	13,5	13,9	13,8	13,0	13,2	12,1	10,5	10,8	10,4	9,5	8,0	14,0
15,0	-	-	11,9	12,2	12,2	12,0	12,0	10,9	9,9	10,4	10,0	9,0	8,0	15,0
16,0	-	-	10,6	10,9	10,8	11,3	10,8	9,8	9,5	9,8	9,5	9,0	8,0	16,0
18,0	-	-	-	8,8	9,2	9,2	8,9	8,1	8,6	8,5	8,1	7,5	6,8	18,0
20,0	-	-	-	7,3	7,7	7,6	7,3	7,2	7,6	7,3	6,8	6,2	5,6	20,0
22,0	-	-	-	-	6,5	6,3	6,0	6,4	6,4	6,2	5,7	5,2	4,6	22,0
24,0	-	-	-	-	5,5	5,5	5,1	5,6	5,4	5,2	4,9	4,4	3,8	24,0
26,0	-	-	-	-	-	4,9	4,7	4,8	4,6	4,4	4,1	3,7	3,1	26,0
28,0	-	-	-	-	-	4,2	4,2	4,1	3,9	3,7	3,5	3,0	2,5	28,0
30,0	-	-	-	-	-	-	3,6	3,5	3,3	3,1	2,9	2,5	2,0	30,0
32,0	-	-	-	-	-	-	2,4	3,0	2,8	2,6	2,4	2,1	1,6	32,0
34,0	-	-	-	-	-	-	-	2,6	2,4	2,2	2,0	1,6	1,2	34,0
36,0	-	-	-	-	-	-	-	1,1	2,0	1,8	1,6	1,3	-	36,0
38,0	-	-	-	-	-	-	-	-	1,7	1,5	1,2	1,0	-	38,0
40,0	-	-	-	-	-	-	-	-	1,4	1,2	0,9	-	-	40,0
42,0	-	-	-	-	-	-	-	-	-	0,9	-	-	-	42,0

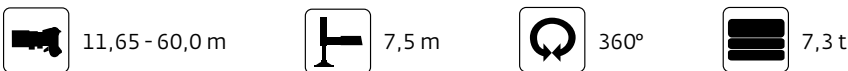

m	11,65	15,90	20,11	24,26	28,25	32,11	35,83	40,08	44,29	48,43	52,43	56,28	60,00	m
3,0	69,0	63,5	59,0	56,0	-	-	-	-	-	-	-	-	-	3,0
4,0	59,0	56,0	52,5	49,5	47,0	-	-	-	-	-	-	-	-	4,0
5,0	52,0	49,5	47,0	44,5	41,5	37,5	-	-	-	-	-	-	-	5,0
6,0	43,5	44,0	41,5	40,5	38,0	36,0	30,0	23,0	-	-	-	-	-	6,0
7,0	36,0	37,0	35,5	33,0	32,0	30,0	29,0	23,0	18,0	-	-	-	-	7,0
8,0	30,0	31,0	29,5	28,5	26,5	26,5	24,5	22,5	18,0	14,3	-	-	-	8,0
9,0	24,0	25,5	25,5	24,5	24,0	22,5	21,0	19,2	18,0	14,3	11,6	-	-	9,0
10,0	-	21,0	22,0	21,0	21,0	19,6	18,0	17,7	15,7	14,3	11,6	9,5	-	10,0
11,0	-	17,8	18,5	18,5	18,3	17,1	16,1	15,7	13,6	13,2	11,6	9,5	8,0	11,0
12,0	-	15,5	15,8	16,7	16,1	15,0	15,1	13,8	11,9	11,8	11,4	9,5	8,0	12,0
13,0	-	12,9	14,2	14,5	14,3	13,5	13,5	12,3	11,0	11,3	10,4	9,5	8,0	13,0
14,0	-	-	12,4	12,7	12,6	12,7	12,1	11,0	10,5	10,8	10,4	9,0	8,0	14,0
15,0	-	-	10,9	11,2	11,1	11,7	10,9	9,8	9,9	9,7	9,6	8,9	8,0	15,0
16,0	-	-	9,6	9,9	10,2	10,4	9,8	8,9	9,5	8,8	8,7	8,1	7,4	16,0
18,0	-	-	-	8,0	8,5	8,4	8,0	7,9	8,1	7,3	7,2	6,6	6,0	18,0
20,0	-	-	-	6,8	7,0	6,9	6,5	7,2	6,9	6,0	6,0	5,5	4,9	20,0
22,0	-	-	-	-	5,8	6,1	5,8	6,0	5,8	5,0	5,0	4,5	4,0	22,0
24,0	-	-	-	-	4,9	5,1	5,1	5,1	4,9	4,2	4,2	3,7	3,2	24,0
26,0	-	-	-	-	-	4,3	4,3	4,3	4,1	3,5	3,5	3,1	2,6	26,0
28,0	-	-	-	-	-	3,7	3,7	3,6	3,4	2,9	3,0	2,5	2,0	28,0
30,0	-	-	-	-	-	-	3,1	3,1	2,9	2,3	2,4	2,0	1,5	30,0
32,0	-	-	-	-	-	-	2,0	2,6	2,4	1,8	2,0	1,6	1,1	32,0
34,0	-	-	-	-	-	-	-	2,2	2,0	1,4	1,6	1,2	1,2	34,0
36,0	-	-	-	-	-	-	-	-	1,6	1,1	1,2	0,9	-	36,0
38,0	-	-	-	-	-	-	-	-	1,3	1,1	0,9	-	-	38,0
40,0	-	-	-	-	-	-	-	-	1,0	-	-	-	-	40,0

# Load charts • Traglasten • Capacités de levage Capacidades • Capacità • Таблицы грузоподъемности

Telescopic boom • Teleskopausleger • Flèche principale • Pluma telescópica • Braccio telescopico • Телескопическая стрела

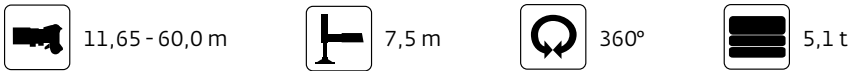

m	11,65	15,90	20,11	24,26	28,25	32,11	35,83	40,08	44,29	48,43	52,43	56,28	60,00	m
3,0	69,0	63,5	59,0	56,0	-	-	-	-	-	-	-	-	-	3,0
4,0	59,0	56,0	52,5	49,5	47,0	-	-	-	-	-	-	-	-	4,0
5,0	52,0	49,5	47,0	44,5	41,5	37,5	-	-	-	-	-	-	-	5,0
6,0	42,5	43,0	41,0	38,0	36,5	33,5	30,0	23,0	-	-	-	-	-	6,0
7,0	35,0	35,5	33,0	32,0	30,0	29,0	27,0	23,0	18,0	-	-	-	-	7,0
8,0	28,0	29,5	27,5	26,5	26,0	24,5	22,5	20,5	18,0	14,3	-	-	-	8,0
9,0	22,0	24,0	24,0	22,5	22,5	21,0	19,0	18,8	16,5	14,3	11,6	-	-	9,0
10,0	-	19,6	20,5	19,9	19,3	17,9	17,0	16,3	14,1	13,6	11,6	9,5	-	10,0
11,0	-	16,7	17,1	17,7	16,7	15,5	15,6	14,2	12,5	12,1	11,6	9,5	8,0	11,0
12,0	-	14,0	15,0	15,4	14,6	14,2	13,8	12,5	11,6	11,8	10,5	9,5	8,0	12,0
13,0	-	11,6	12,9	13,2	12,9	13,2	12,2	11,1	11,0	10,8	10,4	9,0	8,0	13,0
14,0	-	-	11,2	11,5	11,4	11,8	10,9	9,9	10,5	10,2	10,4	8,8	8,0	14,0
15,0	-	-	9,8	10,1	10,8	10,6	9,8	9,4	9,6	9,2	9,6	7,9	7,2	15,0
16,0	-	-	8,6	9,0	9,6	9,4	8,8	8,9	8,9	8,3	8,6	7,1	6,5	16,0
18,0	-	-	-	7,5	7,7	7,6	7,3	7,8	7,3	6,9	7,8	5,8	5,2	18,0
20,0	-	-	-	6,1	6,3	6,5	6,5	6,5	6,1	5,7	6,4	4,7	4,1	20,0
22,0	-	-	-	-	5,2	5,4	5,4	5,4	5,2	4,8	5,3	3,9	3,3	22,0
24,0	-	-	-	-	4,3	4,5	4,5	4,5	4,3	4,0	4,4	3,1	2,6	24,0
26,0	-	-	-	-	-	3,8	3,8	3,7	3,5	3,3	3,6	2,5	2,0	26,0
28,0	-	-	-	-	-	3,2	3,2	3,1	3,4	2,7	3,0	2,0	1,5	28,0
30,0	-	-	-	-	-	2,6	2,6	2,6	2,9	2,2	2,4	1,5	1,0	30,0
32,0	-	-	-	-	-	1,5	1,5	2,2	2,4	1,8	1,9	1,1	-	32,0
34,0	-	-	-	-	-	-	-	1,8	2,0	1,4	1,5	-	-	34,0
36,0	-	-	-	-	-	-	-	-	1,6	1,1	1,1	-	-	36,0
38,0	-	-	-	-	-	-	-	-	1,2	-	-	-	-	38,0
40,0	-	-	-	-	-	-	-	-	1,0	-	-	-	-	40,0

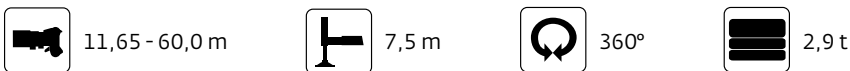

m	11,65	15,90	20,11	24,26	28,25	32,11	35,83	40,08	44,29	48,43	52,43	56,28	60,00	m
3,0	69,0	63,5	59,0	56,0	-	-	-	-	-	-	-	-	-	3,0
4,0	59,0	56,0	52,5	49,5	47,0	-	-	-	-	-	-	-	-	4,0
5,0	51,5	49,5	47,0	44,5	41,5	37,5	-	-	-	-	-	-	-	5,0
6,0	41,5	42,0	39,0	35,5	34,0	32,0	30,0	23,0	-	-	-	-	-	6,0
7,0	34,0	33,5	31,0	30,0	28,0	27,0	25,0	22,5	18,0	-	-	-	-	7,0
8,0	26,0	27,5	31,0	25,0	24,5	22,5	20,5	19,7	17,5	14,3	-	-	-	8,0
9,0	20,5	22,0	26,5	21,5	20,5	18,9	18,2	17,1	14,7	14,2	11,6	-	-	9,0
10,0	-	18,3	22,0	18,5	17,5	16,2	16,2	14,7	13,1	12,2	11,6	9,5	-	10,0
11,0	-	15,0	18,3	16,0	15,1	15,1	14,1	12,8	12,5	12,1	10,5	9,5	8,0	11,0
12,0	-	12,5	16,1	13,9	13,2	13,4	12,4	11,2	11,6	11,1	10,4	9,0	8,0	12,0
13,0	-	10,3	13,6	11,9	12,1	11,9	10,9	10,5	10,7	10,2	9,5	8,8	8,0	13,0
14,0	-	-	11,6	10,3	11,0	10,6	9,7	9,9	9,7	9,1	8,5	7,8	7,1	14,0
15,0	-	-	8,7	9,4	9,7	9,5	8,7	9,3	8,7	8,2	7,6	7,0	6,3	15,0
16,0	-	-	7,7	8,4	8,6	8,4	8,1	8,4	7,9	7,4	6,8	6,2	5,6	16,0
18,0	-	-	-	6,7	6,8	7,1	7,1	6,9	6,5	6,0	5,5	5,0	4,4	18,0
20,0	-	-	-	5,4	5,6	5,8	5,8	5,7	5,4	5,0	4,5	4,0	3,4	20,0
22,0	-	-	-	-	4,6	4,8	4,7	4,7	4,5	4,1	3,7	3,2	2,6	22,0
24,0	-	-	-	-	3,7	3,9	3,9	3,9	3,7	3,4	2,9	2,5	1,9	24,0
26,0	-	-	-	-	-	3,3	3,2	3,2	3,0	2,7	2,3	1,9	1,3	26,0
28,0	-	-	-	-	-	2,7	2,7	2,6	2,4	2,2	1,8	1,4	-	28,0
30,0	-	-	-	-	-	2,2	2,2	2,1	1,9	1,7	1,4	0,9	-	30,0
32,0	-	-	-	-	-	1,1	1,7	1,7	1,5	1,3	1,0	-	-	32,0
34,0	-	-	-	-	-	-	-	1,3	1,1	0,9	-	-	-	34,0

# Load charts • Traglasten • Capacités de levage Capacidades • Capacità • Таблицы грузоподъемности

Jib configurations • Kombination der Auslegerverlängerung • Combinaisons de l'extension treillis  
Configuración con extensiones de pluma • Combinazioni delle prolunghie del falcone • Конфигурации стрелы

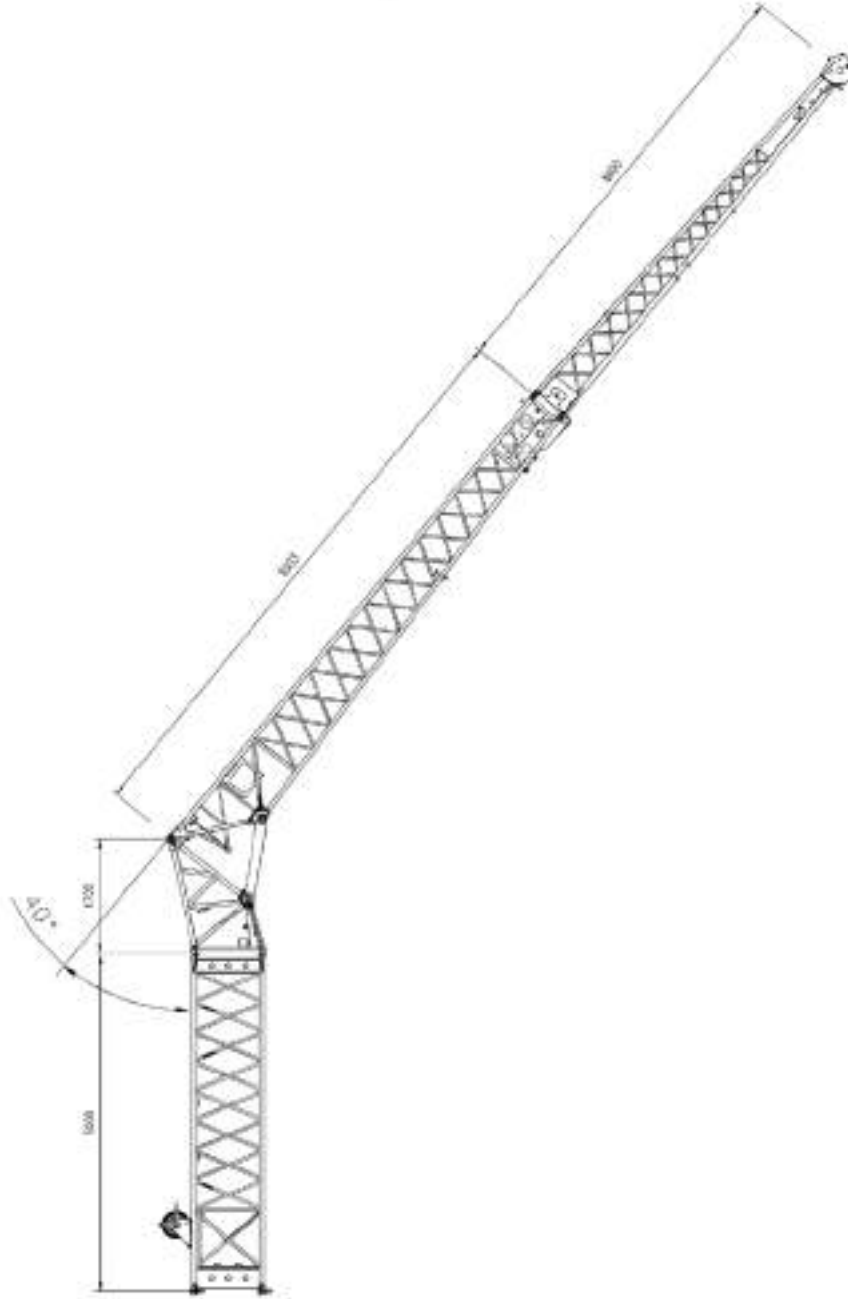

Total Length Gesamtlänge Longueur totale Longitud total Lunghezza Totale Общая длина [m]	Intermediate section boom extension make-up Reihenfolge des Spitzenaufbaus Ordre des combinaisons de l'extension treillis Combinaciones de tramos intermedios de extensión de pluma Sequenza di combinazioni per le sezioni di traliccio del falcone Сборка промежуточной секции гуська крана				
10,0	5,0 m	1,7 m	8,5 m	6,6 m	-
17,0	—	1x	1x	—	-
22,0	—	1x	1x	1x	1x
	1x	1x	1x	1x	1x

# Load charts • Traglasten • Capacités de levage Capacidades • Capacità • Таблицы грузоподъемности

Swingaway (hydraulic luffing) • Klappspitze (hydraulisch wippbar) • Extension treillis (déport hydraulique) • Plumín (angulable hidráulicamente) • Falcone (brandeggio idraulico) • Складной удлинитель стрелы (гидравлическое изменение вылета)



56,28 - 60,00 m



10,0 / 17,0 m



7,5 m



360°



27,2 t



EN 13000

m m	56,3			60,0			m m
	10,0			10,0			
	0°	20°	40°	0	20°	40	
10,0	5,2	-	-	-	-	-	10,0
11,0	5,2	-	-	4,2	-	-	11,0
12,0	5,2	-	-	4,2	-	-	12,0
13,0	5,2	-	-	4,2	-	-	13,0
14,0	5,2	4,8	-	4,2	-	-	14,0
15,0	5,2	4,8	-	4,2	-	-	15,0
16,0	5,2	4,8	-	4,2	4,0	-	16,0
18,0	5,2	4,8	4,3	4,2	4,0	3,8	18,0
20,0	5,2	4,8	4,3	4,2	4,0	3,8	20,0
22,0	5,2	4,8	4,3	4,2	4,0	3,8	22,0
24,0	5,2	4,8	4,3	4,2	4,0	3,8	24,0
26,0	5,2	4,8	4,3	4,2	4,0	3,8	26,0
28,0	5,1	4,8	4,3	4,2	4,0	3,8	28,0
30,0	4,8	4,7	4,3	4,2	4,0	3,8	30,0
32,0	4,5	4,5	4,3	4,2	4,0	3,8	32,0
34,0	4,0	4,0	4,3	3,9	3,9	3,8	34,0
36,0	3,6	3,6	3,7	3,6	3,6	3,7	36,0
38,0	3,3	3,4	3,5	3,1	3,1	3,4	38,0
40,0	3,0	3,0	3,2	2,7	2,7	2,9	40,0
42,0	2,6	2,6	2,8	2,3	2,3	2,5	42,0
44,0	2,3	2,3	2,4	1,9	1,9	2,1	44,0
46,0	1,9	1,9	2,1	1,6	1,6	1,8	46,0
48,0	1,7	1,7	1,8	1,3	1,3	1,5	48,0
50,0	1,4	1,4	1,5	1,0	1,0	1,2	50,0
52,0	1,1	1,1	1,2	0,8	0,8	0,9	52,0
54,0	0,9	0,9	-	-	-	0,7	54,0
56,0	0,7	0,7	-	-	-	-	56,0

m m	56,3			60,0			m m
	17,0			17,0			
	0°	20°	40°	0°	20°	40°	
11,0	3,5	-	-	-	-	-	11,0
12,0	3,5	-	-	2,9	-	-	12,0
13,0	3,5	-	-	2,9	-	-	13,0
14,0	3,5	-	-	2,9	-	-	14,0
15,0	3,5	-	-	2,9	-	-	15,0
16,0	3,5	-	-	2,9	-	-	16,0
18,0	3,5	3,3	-	2,9	-	-	18,0
20,0	3,5	3,3	-	2,9	2,7	-	20,0
22,0	3,5	3,3	2,6	2,9	2,7	-	22,0
24,0	3,5	3,3	2,6	2,9	2,7	2,4	24,0
26,0	3,5	3,2	2,6	2,9	2,7	2,4	26,0
28,0	3,5	3,1	2,6	2,9	2,7	2,4	28,0
30,0	3,5	2,9	2,5	2,9	2,7	2,4	30,0
32,0	3,5	2,8	2,5	2,9	2,7	2,4	32,0
34,0	3,5	2,7	2,4	2,9	2,7	2,4	34,0
36,0	3,5	2,6	2,4	2,9	2,7	2,4	36,0
38,0	3,2	2,6	2,3	2,9	2,6	2,4	38,0
40,0	2,9	2,5	2,3	2,9	2,6	2,3	40,0
42,0	2,7	2,4	2,3	2,5	2,5	2,3	42,0
44,0	2,5	2,3	2,2	2,1	2,1	2,3	44,0
46,0	2,2	2,2	2,0	1,8	1,8	2,2	46,0
48,0	1,9	1,9	1,7	1,5	1,5	1,9	48,0
50,0	1,6	1,6	1,4	1,3	1,3	1,6	50,0
52,0	1,4	1,4	1,1	1,0	1,0	1,3	52,0
54,0	1,1	1,1	0,9	0,8	0,8	1,1	54,0
56,0	0,9	0,9	0,7	-	-	0,8	56,0
58,0	0,7	0,7	-	-	-	-	58,0

# Load charts • Traglasten • Capacités de levage Capacidades • Capacità • Таблицы грузоподъемности

Swingaway (hydraulic luffing) • Klappspitze (hydraulisch wippbar) • Extension treillis (déport hydraulique) • Plumín (angulable hidráulicamente) • Falcone (brandeggio idraulico) • Складной удлинитель стрелы (гидравлическое изменение вылета)



56,28 - 60,00 m



22,0 m



7,0 m



360°



27,2 t



EN 13000

m m	56,3			60,0			m m
	22,0			22,0			
	0°	20°	40°	0°	20°	40°	
14,0	2,4	-	-	2,0	-	-	14,0
15,0	2,4	-	-	2,0	-	-	15,0
16,0	2,4	-	-	2,0	-	-	16,0
18,0	2,4	-	-	2,0	-	-	18,0
20,0	2,4	2,4	-	2,0	-	-	20,0
22,0	2,4	2,4	-	2,0	2,0	-	22,0
24,0	2,4	2,4	2,4	2,0	2,0	2,0	24,0
26,0	2,4	2,4	2,3	2,0	2,0	2,0	26,0
28,0	2,4	2,4	2,3	2,0	2,0	2,0	28,0
30,0	2,4	2,4	2,3	2,0	2,0	2,0	30,0
32,0	2,4	2,4	2,2	2,0	2,0	2,0	32,0
34,0	2,4	2,4	2,2	2,0	2,0	2,0	34,0
36,0	2,4	2,3	2,2	2,0	2,0	2,0	36,0
38,0	2,4	2,2	2,1	2,0	2,0	2,0	38,0
40,0	2,4	2,2	2,1	2,0	2,0	2,0	40,0
42,0	2,3	2,1	2,0	2,0	2,0	2,0	42,0
44,0	2,1	2,0	2,0	2,0	2,0	2,0	44,0
46,0	2,0	1,8	2,0	1,7	1,7	1,9	46,0
48,0	1,8	1,5	1,9	1,4	1,4	1,8	48,0
50,0	1,5	1,3	1,8	1,2	1,2	1,5	50,0
52,0	1,3	1,1	1,6	0,9	0,9	1,2	52,0
54,0	1,1	0,9	1,3	0,7	0,7	1,0	54,0
56,0	0,9	-	1,1	-	0,9	0,8	56,0
58,0	-	-	0,9	-	-	-	58,0

# Load charts • Traglasten • Capacités de levage Capacidades • Capacità • Таблицы грузоподъемности

Swingaway (hydraulic luffing) • Klappspitze (hydraulisch wippbar) • Extension treillis (déport hydraulique) • Plumín (angulable hidráulicamente) • Falcone (brandeggio idraulico) • Складной удлинитель стрелы (гидравлическое изменение вылета)



56,28 - 60,00 m



10,0 / 17,0 m



7,5 m



360°



22,7 t



EN 13000

m m	56,3			60,0			m m
	10,0			10,0			
	0°	20°	40°	0	20°	40	
10,0	5,2	-	-	-	-	-	10,0
11,0	5,2	-	-	4,2	-	-	11,0
12,0	5,2	-	-	4,2	-	-	12,0
13,0	5,2	-	-	4,2	-	-	13,0
14,0	5,2	4,8	-	4,2	-	-	14,0
15,0	5,2	4,8	-	4,2	-	-	15,0
16,0	5,2	4,8	-	4,2	4,0	-	16,0
18,0	5,2	4,8	4,3	4,2	4,0	3,8	18,0
20,0	5,2	4,8	4,3	4,2	4,0	3,8	20,0
22,0	5,2	4,8	4,3	4,2	4,0	3,8	22,0
24,0	5,2	4,8	4,3	4,2	4,0	3,8	24,0
26,0	5,2	4,8	4,3	4,2	4,0	3,8	26,0
28,0	5,0	4,8	4,3	4,2	4,0	3,8	28,0
30,0	4,3	4,3	4,3	4,2	4,0	3,8	30,0
32,0	4,1	4,0	4,1	3,9	3,9	3,8	32,0
34,0	3,8	3,8	3,8	3,3	3,3	3,7	34,0
36,0	3,3	3,3	3,6	2,9	2,9	3,2	36,0
38,0	2,9	2,9	3,1	2,4	2,4	2,7	38,0
40,0	2,4	2,4	2,7	2,0	2,0	2,3	40,0
42,0	2,1	2,1	2,3	1,7	1,7	1,9	42,0
44,0	1,7	1,7	1,9	1,4	1,4	1,6	44,0
46,0	1,4	1,4	1,6	1,1	1,1	1,3	46,0
48,0	1,2	1,2	1,3	0,8	0,8	1,0	48,0
50,0	0,9	0,9	1,0	-	-	0,7	50,0
52,0	0,7	0,7	0,8	-	-	-	52,0

m m	56,3			60,0			m m
	17,0			17,0			
	0°	20°	40°	0°	20°	40°	
11,0	3,5	-	-	-	-	-	11,0
12,0	3,5	-	-	2,9	-	-	12,0
13,0	3,5	-	-	2,9	-	-	13,0
14,0	3,5	-	-	2,9	-	-	14,0
15,0	3,5	-	-	2,9	-	-	15,0
16,0	3,5	-	-	2,9	-	-	16,0
18,0	3,5	3,3	-	2,9	-	-	18,0
20,0	3,5	3,3	-	2,9	2,7	-	20,0
22,0	3,5	3,3	2,6	2,9	2,7	-	22,0
24,0	3,5	3,3	2,6	2,9	2,7	2,4	24,0
26,0	3,5	3,2	2,6	2,9	2,7	2,4	26,0
28,0	3,5	3,1	2,6	2,9	2,7	2,4	28,0
30,0	3,5	2,9	2,5	2,9	2,7	2,4	30,0
32,0	3,5	2,8	2,5	2,9	2,7	2,4	32,0
34,0	3,4	2,7	2,4	2,9	2,7	2,4	34,0
36,0	3,0	2,6	2,4	2,9	2,7	2,4	36,0
38,0	3,0	2,6	2,3	2,6	2,6	2,4	38,0
40,0	2,7	2,5	2,3	2,2	2,2	2,3	40,0
42,0	2,3	2,3	2,3	1,9	1,9	2,3	42,0
44,0	2,0	2,0	2,2	1,5	1,5	2,0	44,0
46,0	1,7	1,7	2,0	1,3	1,3	1,6	46,0
48,0	1,4	1,4	1,7	1,0	1,0	1,3	48,0
50,0	1,1	1,1	1,4	0,7	0,7	1,1	50,0
52,0	0,9	0,9	1,1	-	-	0,8	52,0
54,0	0,7	0,7	0,9	-	-	-	54,0
56,0	-	-	0,7	-	-	-	56,0



# Load charts • Traglasten • Capacités de levage Capacidades • Capacità • Таблицы грузоподъемности

Swingaway (hydraulic luffing) • Klappspitze (hydraulisch wippbar) • Extension treillis (déport hydraulique) • Plumín (angulable hidráulicamente) • Falcone (brandeggio idraulico) • Складной удлинитель стрелы (гидравлическое изменение вылета)



56,28 - 60,00 m



22,0 m



7,0 m



360°



22,7 t



EN 13000

m m	56,3			60,0			m m
	22,0			22,0			
	0°	20°	40°	0°	20°	40°	
12,0	2,4	-	-	2,0	-	-	12,0
13,0	2,4	-	-	2,0	-	-	13,0
14,0	2,4	-	-	2,0	-	-	14,0
15,0	2,4	-	-	2,0	-	-	15,0
16,0	2,4	-	-	2,0	-	-	16,0
18,0	2,4	-	-	2,0	-	-	18,0
20,0	2,4	2,4	-	2,0	-	-	20,0
22,0	2,4	2,4	-	2,0	2,0	-	22,0
24,0	2,4	2,4	2,4	2,0	2,0	2,0	24,0
26,0	2,4	2,4	2,3	2,0	2,0	2,0	26,0
28,0	2,4	2,4	2,3	2,0	2,0	2,0	28,0
30,0	2,4	2,4	2,3	2,0	2,0	2,0	30,0
32,0	2,4	2,4	2,2	2,0	2,0	2,0	32,0
34,0	2,4	2,4	2,2	2,0	2,0	2,0	34,0
36,0	2,4	2,3	2,2	2,0	2,0	2,0	36,0
38,0	2,4	2,2	2,1	2,0	2,0	2,0	38,0
40,0	2,1	2,1	2,1	2,0	2,0	2,0	40,0
42,0	1,9	2,1	2,0	1,7	1,7	2,0	42,0
44,0	1,6	1,9	2,0	1,4	1,4	1,8	44,0
46,0	1,3	1,6	1,9	1,1	1,1	1,5	46,0
48,0	1,1	1,3	1,6	0,9	0,9	1,2	48,0
50,0	0,8	1,1	1,4	-	-	1,0	50,0
52,0	-	0,8	1,1	-	-	0,7	52,0
54,0	-	-	0,9	-	-	-	54,0

# Load charts • Traglasten • Capacités de levage Capacidades • Capacità • Таблицы грузоподъемности

Swingaway (hydraulic luffing) • Klappspitze (hydraulisch wippbar) • Extension treillis (déport hydraulique) • Plumín (angulable hidráulicamente) • Falcone (brandeggio idraulico) • Складной удлинитель стрелы (гидравлическое изменение вылета)



56,28 - 60,00 m



10,0 / 17,0 m



7,5 m



360°



11,7 t



EN 13000

m m	56,3			60,0			m m
	10,0			10,0			
	0°	20°	40°	0	20°	40	
10,0	5,2	-	-	-	-	-	10,0
11,0	5,2	-	-	4,2	-	-	11,0
12,0	5,2	-	-	4,2	-	-	12,0
13,0	5,2	-	-	4,2	-	-	13,0
14,0	5,2	4,8	-	4,2	-	-	14,0
15,0	5,2	4,8	-	4,2	-	-	15,0
16,0	5,2	4,8	-	4,2	4,0	-	16,0
18,0	5,2	4,8	4,3	4,2	4,0	3,8	18,0
20,0	5,2	4,8	4,3	4,2	4,0	3,8	20,0
22,0	4,6	4,6	4,3	4,2	4,0	3,8	22,0
24,0	4,4	4,4	4,3	3,9	3,9	3,8	24,0
26,0	3,7	3,7	4,0	3,2	3,2	3,7	26,0
28,0	3,1	3,1	3,5	2,6	2,6	3,0	28,0
30,0	2,6	2,6	2,9	2,0	2,0	2,4	30,0
32,0	2,1	2,1	2,4	1,6	1,6	1,9	32,0
34,0	1,7	1,7	2,0	1,2	1,2	1,5	34,0
36,0	1,3	1,3	1,6	0,8	0,8	1,1	36,0
38,0	1,0	1,0	1,2	-	-	0,8	38,0
40,0	-	-	1,2	-	-	-	40,0
42,0	-	-	0,9	-	-	-	42,0

m m	56,3			60,0			m m
	17,0			17,0			
	0°	20°	40°	0°	20°	40°	
11,0	3,5	-	-	-	-	-	11,0
12,0	3,5	-	-	2,9	-	-	12,0
13,0	3,5	-	-	2,9	-	-	13,0
14,0	3,5	-	-	2,9	-	-	14,0
15,0	3,5	-	-	2,9	-	-	15,0
16,0	3,5	-	-	2,9	-	-	16,0
18,0	3,5	3,3	-	2,9	-	-	18,0
20,0	3,5	3,3	-	2,9	2,7	-	20,0
22,0	3,5	3,3	2,6	2,9	2,7	-	22,0
24,0	3,5	3,3	2,6	2,9	2,7	2,4	24,0
26,0	3,2	3,2	2,6	2,9	2,7	2,4	26,0
28,0	3,0	2,8	2,6	2,7	2,7	2,4	28,0
30,0	2,7	2,7	2,5	2,2	2,2	2,4	30,0
32,0	2,2	2,2	2,5	1,8	1,8	2,4	32,0
34,0	1,8	1,8	2,4	1,4	1,4	2,0	34,0
36,0	1,5	1,5	2,0	1,0	1,0	1,6	36,0
38,0	1,1	1,1	1,6	0,7	0,7	1,2	38,0
40,0	0,8	0,8	1,3	-	0,9	0,9	40,0
42,0	-	-	1,0	-	-	-	42,0
44,0	-	-	0,7	-	-	-	44,0

# Load charts • Traglasten • Capacités de levage Capacidades • Capacità • Таблицы грузоподъемности

Swingaway (hydraulic luffing) • Klappspitze (hydraulisch wippbar) • Extension treillis (déport hydraulique) • Plumín (angulable hidráulicamente) • Falcone (brandeggio idraulico) • Складной удлинитель стрелы (гидравлическое изменение вылета)



56,28 - 60,00 m



22,0 m



7,0 m



360°



11,7 t



EN 13000

m m	56,3			60,0			m m
	22,0			22,0			
	0°	20°	40°	0°	20°	40°	
12,0	2,4	-	-	2,0	-	-	12,0
13,0	2,4	-	-	2,0	-	-	13,0
14,0	2,4	-	-	2,0	-	-	14,0
15,0	2,4	-	-	2,0	-	-	15,0
16,0	2,4	-	-	2,0	-	-	16,0
18,0	2,4	-	-	2,0	-	-	18,0
20,0	2,4	2,4	-	2,0	-	-	20,0
22,0	2,4	2,4	-	2,0	2,0	-	22,0
24,0	2,4	2,4	2,4	2,0	2,0	2,0	24,0
26,0	2,4	2,4	2,3	2,0	2,0	2,0	26,0
28,0	2,4	2,4	2,3	2,0	2,0	2,0	28,0
30,0	2,1	2,1	2,3	2,0	2,0	2,0	30,0
32,0	2,1	1,7	2,2	1,6	1,6	2,0	32,0
34,0	1,7	1,3	2,1	1,2	1,2	1,9	34,0
36,0	1,3	1,0	1,9	0,9	0,9	1,5	36,0
38,0	1,0	0,7	1,5	-	-	1,1	38,0
40,0	0,7	-	1,2	-	-	0,8	40,0
42,0	-	-	0,9	-	-	-	42,0

# Load charts • Traglasten • Capacités de levage Capacidades • Capacità • Таблицы грузоподъемности

Working range • Arbeitsbereiche • Diagramme de levage • Gama de trabajo • Area di lavoro • Грузовысотные характеристики

Integrated heavy duty jib • Integrierte Schwerlastspitze • Flèche intégrée haute résistance • Pluma integrada de alta resistencia • Braccio integrato ad alta resistenza • Интегрированная стрела для тяжелых условий эксплуатации

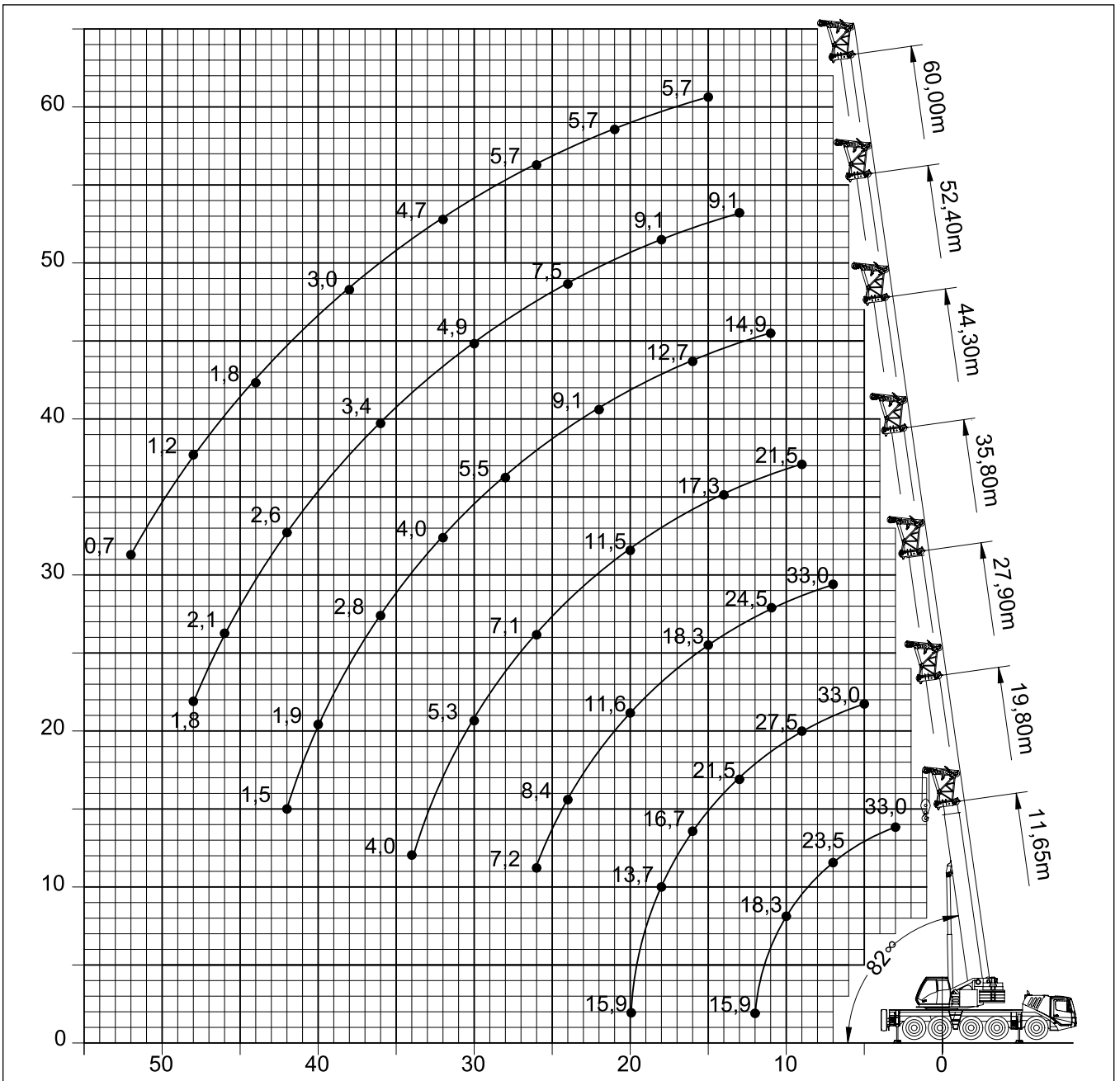
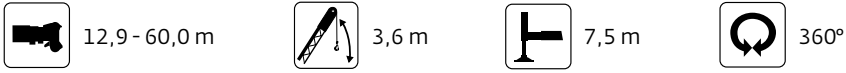

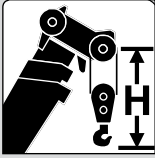
	Hook block • Hakenflasche • Crochet-moufle • Gancho • Ganci • Крюковой блок (t)	H (mm)
	120 D	3160
100 D	3160	
75 D	3070	
50 E	3000	
20 E	2770	
8 H/B	2350	







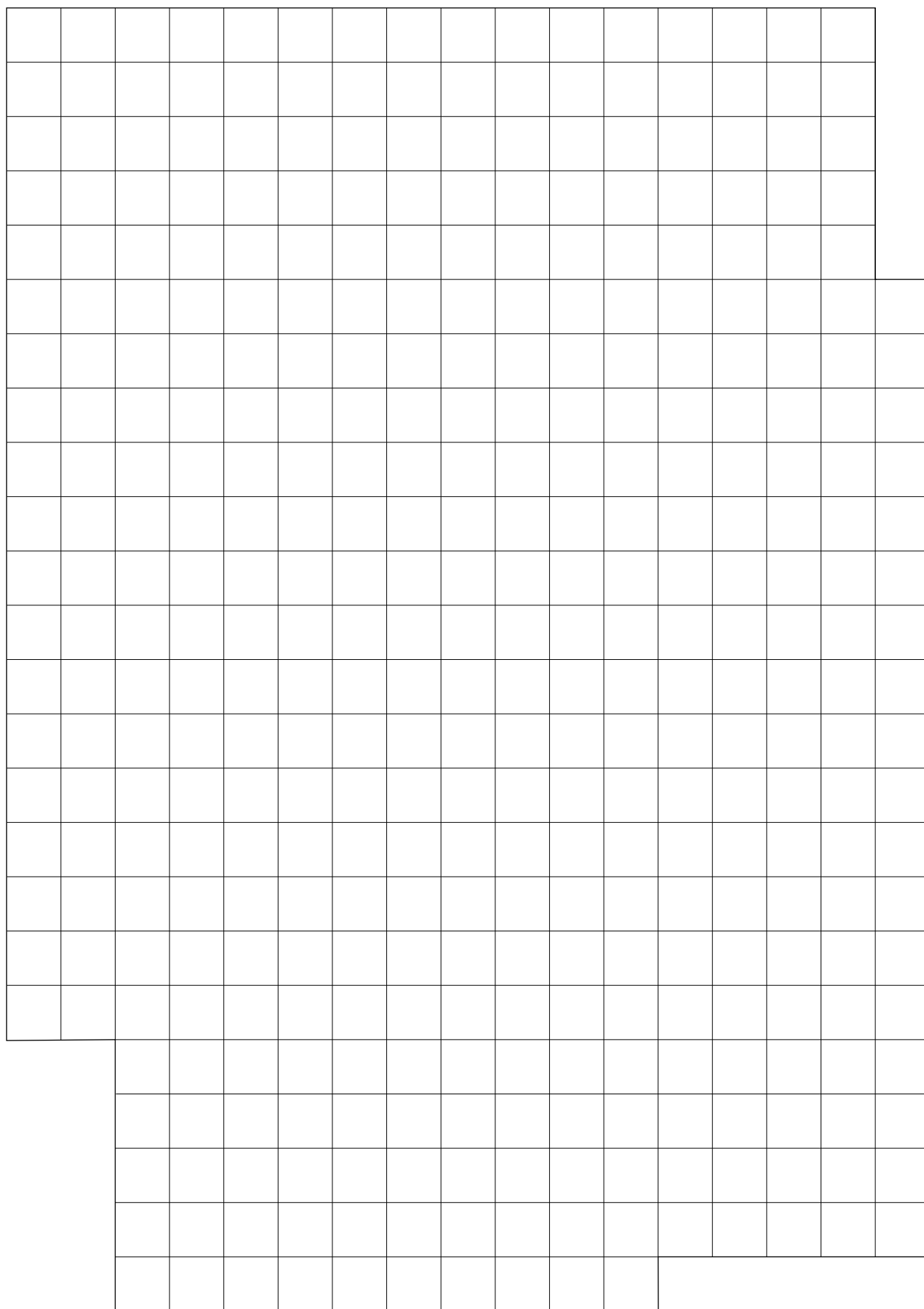



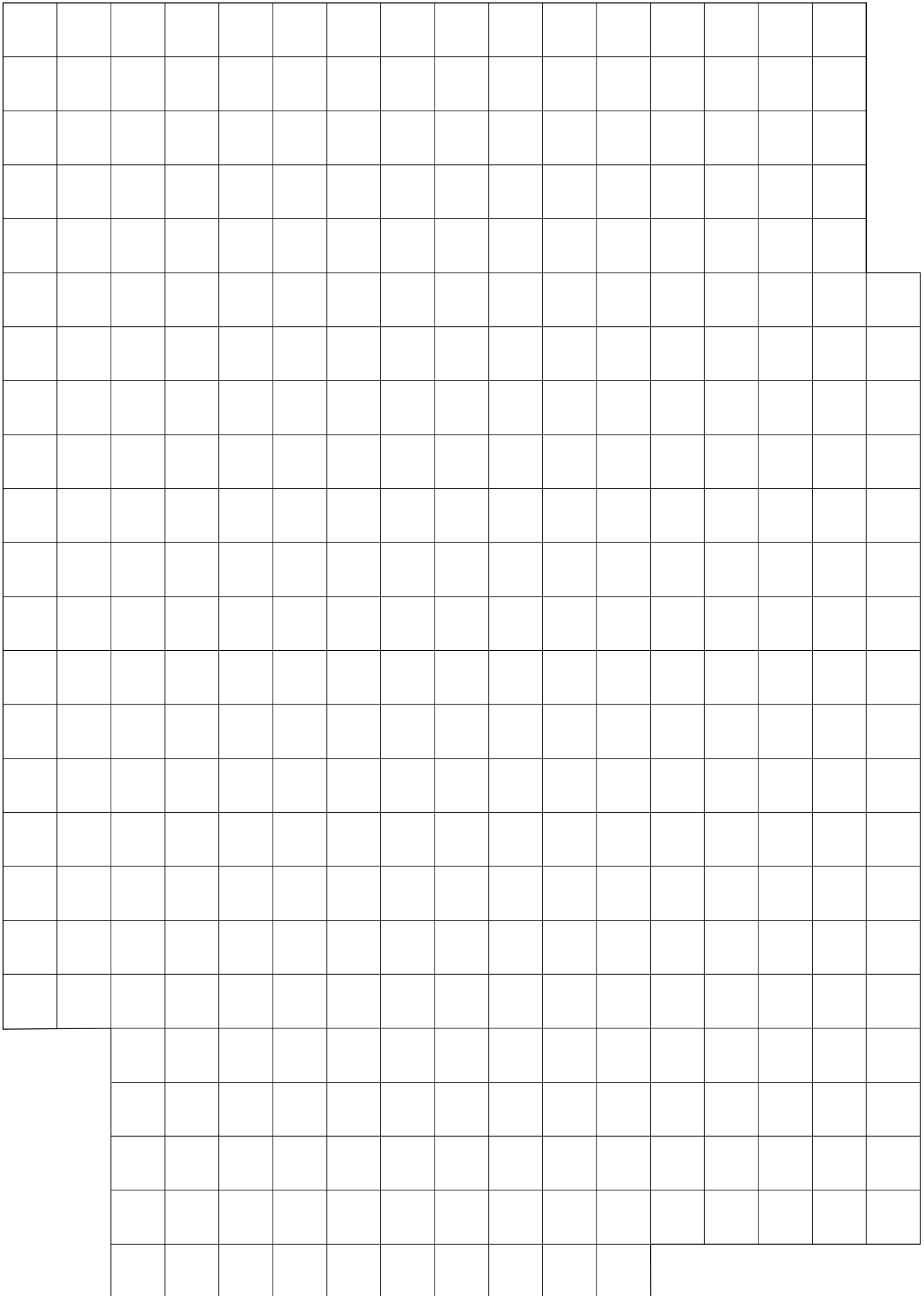

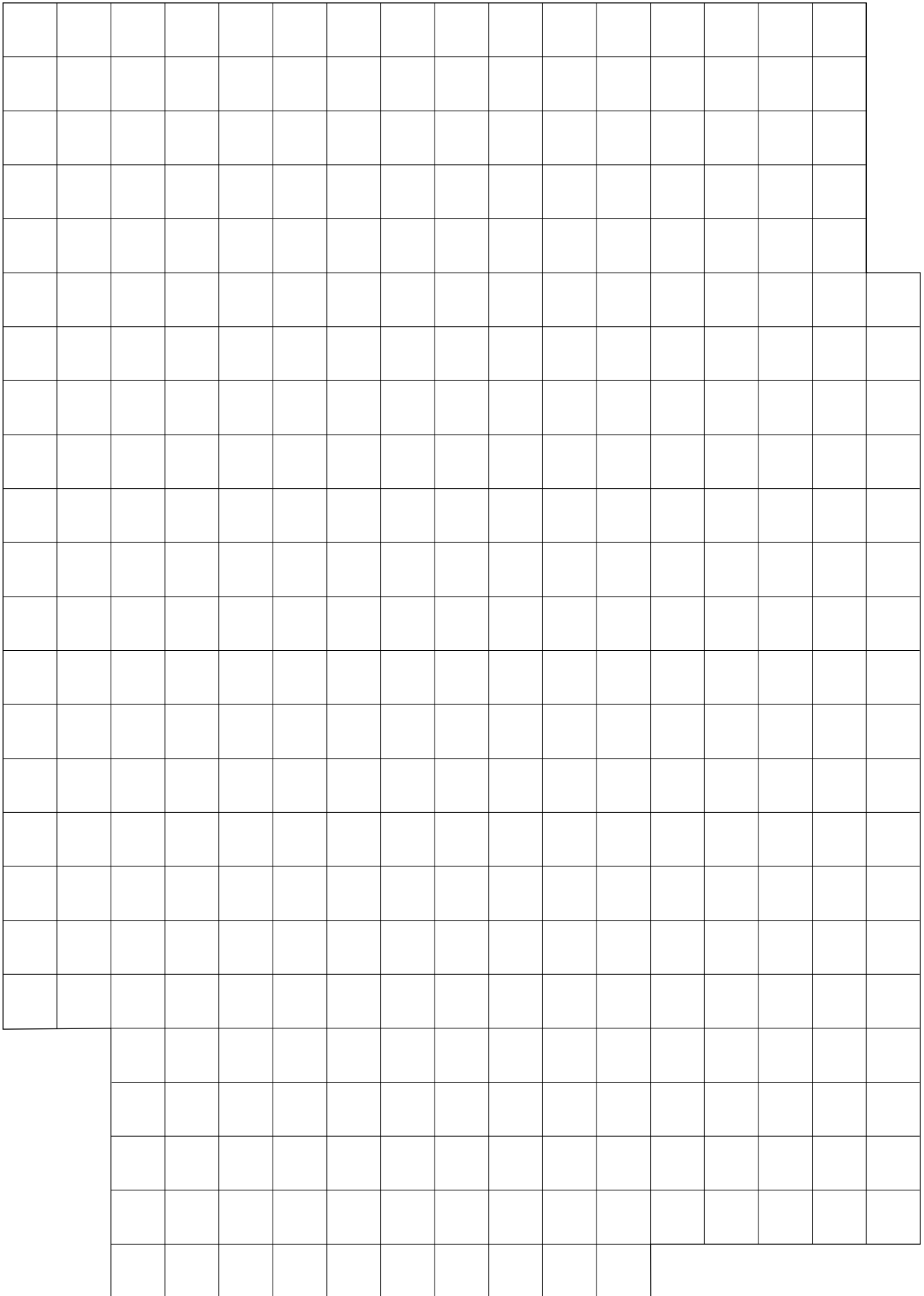































# Notes • Hinweise • Notes • Notas • Note • Примечания

## Symbols • Symbolerklärung • Glossaire des symboles • Glosario de simbolos • Glossario dei simboli • Символы

	Axles Achsen Ponts Ejes Assali Оси		Crane functions Kranbewegungen Mouvements de la grue Funciones de la grúa Funzioni della gru Функции крана		Hookblock / Capacity Hakenflasche / Traglast Moufle / Force de levage Gancho / Capacidad Gancio / Capacità Крюковой блок / Грузоподъемность		Speed Geschwindigkeit Vitesse Velocidad Velocità Скорость
	Axle load Achslast Charge à l'essieu Carga por eje Carico sugli assi Нагрузка на ось		Crane travel Fahrstellung Déplacement de la grue Grúa en traslado Traslazione gru Перемещение крана		Hydraulic system Hydrauliksystem Circuit hydraulique Sistema hidráulico Impianto idraulico Гидравлическая система		Suspension Federung Suspension Suspensión Sospensioni Подвеска
	Boom Ausleger Flèche Pluma Braccio Стрела		Drive/Steer Antrieb/Lenkung Direction/Déplacement Tracción/Dirección Trazione/Sterzo Ведущие/Управляемые оси		Lattice extension Gitterspitze Extension treillis Extensión de celosía Falcone tralicciato Гусек		Transmission / Gear Getriebe / Gang Boîte de vitesses / Rapport Transmisión / Cambio Trasmissione / Cambio Трансмиссия / передача
	Boom elevation Wippwerk Relevage Elevacion de pluma Elevazione braccio Подъем стрелы		Electrical system Elektrische Anlage Circuit électrique Sistema eléctrico Impianto elettrico Электросистема		Lattice extension (luffing) Gitterspitze (wippbar) Extension treillis (volée variable) Extensión de celosía (angulable hidráulicamente) Falcone tralicciato (inclinabile) Гусек (с изменением вылета)		Travel speed Fahrtgeschwindigkeit Vitesse de déplacement Velocidad de desplazamiento Velocità di traslazione Скорость движения
	Boom telescoping Teleskopieren Télescope de flèche Telescopaje de pluma Lunghezza braccio Выдвижение стрелы		Engine Motor Moteur Motor Motore Двигатель		Luffing Jib Wippspitzenausleger Volée variable Plumín angulable Falcone a volata variabile Маневровый гусек		Tyres Bereifung Pneumáticos Neumáticos Pneumatici Шины
	Brakes Bremsen Freins Frenos Freni Тормоза		Free on wheels Freistehend Sur pneus Sobre neumáticos Su gomme Свободные внутренние колеса		Low range Kriechgang Gamme basse Marchas cortas Fuoristrada Низкий диапазон		
	Cab Kabine Cabine Cabina Cabina Кабина		Gradeability Steigfähigkeit Aptitude en pente Superacion de pendientes Pendenza superabile Преодолеваемый уклон		Outriggers Abstützung Calage Estabilizadores Stabilizzatori Выносные опоры		
	Carrier frame Chassis-Rahmen Châssis porteur Bastidor Telaio Рама тягача		Main hoist Haupthubwerk Treuil principal Cabrestante principal Argano principale Лебедка основного подъема		Radius Ausladung Portée Radio Raggio Вылет		
	Counterweight Gegengewicht Contrepoids Contrapeso Contrappeso Противовес		Auxiliary hoist Hilfshubwerk Treuil auxiliaire Cabrestante auxiliar Argano secondario Лебедка вспомогательного подъема		Slewing/Working range Drehwerk/Arbeitsbereich Orientation/Rayon d'opération Giro/Gama de trabajo Rotazione/Area di lavoro Поворот/ Рабочий диапазон		

## Manitowoc Cranes

### Regional headquarters

#### Manitowoc - Americas

Manitowoc, Wisconsin, USA  
Tel: +1 920 684 6621  
Fax: +1 920 683 6277

#### Shady Grove, Pennsylvania, USA

Tel: +1 717 597 8121  
Fax: +1 717 597 4062

#### Manitowoc - Europe, Middle East, Africa

Ecully, France  
Tel: +33 (0)4 72 18 20 20  
Fax: +33 (0)4 72 18 20 00

#### China

Shanghai, China  
Tel: +86 21 6457 0066  
Fax: +86 21 6457 4955

#### Greater Asia-Pacific

Singapore  
Tel: +65 6264 1188  
Fax: +65 6862 4040

### Regional offices

#### Americas

**Brazil**  
Alphaville  
**Mexico**  
Monterrey  
**Chile**  
Santiago

#### Europe, Middle East, Africa

**Czech Republic**  
Netvorice  
**France**  
Baudemont  
Cergy  
Decines  
**Germany**  
Langenfeld  
**Hungary**  
Budapest  
**Italy**  
Lainate  
**Netherlands**  
Breda  
**Poland**  
Warsaw  
**Portugal**  
Baltar  
**Russia**  
Moscow  
**U.A.E.**  
Dubai  
**U.K.**  
Buckingham

#### China

Beijing  
Chengdu  
Guangzhou  
Xian

#### Greater Asia - Pacific

**Australia**  
Adelaide  
Brisbane  
Melbourne  
Sydney  
**India**  
Calcutta  
Chennai  
Delhi  
Hyderabad  
Pune  
**Korea**  
Seoul  
**Philippines**  
Makati City  
**Singapore**

### Factories

**Brazil**  
Alphaville  
**China**  
TaiAn  
Zhangjiagang  
**France**  
Charlieu  
Moulins  
**Germany**  
Wilhelmshaven  
**India**  
Pune  
**Italy**  
Niella Tanaro  
**Portugal**  
Baltar  
Fânzeres  
**Slovakia**  
Sarís  
**U.S.A.**  
Manitowoc  
Port Washington  
Shady Grove

This document is non-contractual. Constant improvement and engineering progress make it necessary that we reserve the right to make specification, equipment, and price changes without notice. Illustrations shown may include optional equipment and accessories and may not include all standard equipment.

Die Angaben in diesem Dokument erfolgen ohne Gewähr. Wir verbessern unsere Produkte ständig und integrieren den technischen Fortschritt. Aus diesem Grund behalten wir uns das Recht vor, die technischen Daten, die Ausstattungsdetails und die Preise unserer Maschinen ohne Vorankündigung zu ändern.

Ce document est non-contractuel. Du fait de sa politique d'amélioration constante de ses produits liée au progrès technique, la Société se réserve le droit de procéder sans préavis à des changements de spécifications, d'équipement ou de prix. Les illustrations peuvent comporter des équipements ou accessoires optionnels ou ne pas comporter des équipements standards.

Este documento no es contractual. El perfeccionamiento constante y el avance tecnológico hacen necesario que la empresa se reserve el derecho de efectuar cambios en las especificaciones, equipo y precios sin previo aviso. En las ilustraciones se puede incluir equipo y accesorios opcionales y es posible que no se muestre el equipo normal.

Documento non contrattuale. In considerazione della sua politica di costante miglioramento dei prodotti connesso al progresso tecnico, la Società si riserva il diritto di modificare senza preavviso specifiche, equipaggiamenti o prezzi. Le illustrazioni possono contenere equipaggiamenti o accessori optional o non contenere equipaggiamenti standard.

Данный документ не является контрактным. Принимая во внимание необходимость постоянного совершенствования и модернизации мы оставляем за собой право изменять спецификации, конструкции и стоимость без предварительного уведомления. Приведенные иллюстрации могут содержать дополнительные компоненты и принадлежности, не входящие в стандартный комплект поставки оборудования.